



Advances of High-precision Riga Event Timers

Yu. Artyukh, V. Bepal'ko, E. Boole, V. Vedin

Institute of Electronics and Computer Science
Riga, LATVIA
www.edi.lv

Two main directions to advancing of high-precision Riga Event Timers:

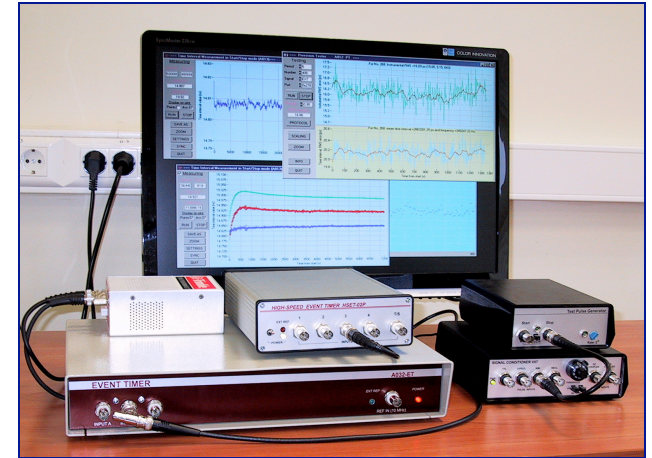

1. Updating the Event Timer A032-ET
2. Development of Event Timer Module

1. Updating the Event Timer A032-ET

1.1. Purposes

The Event Timer A032-ET* still is in demand for SLR applications as commercially available product.

** V. Bespal'ko, E. Boole, V. Vedin. The Model A032-ET of Riga Event Timers. Proceedings of the 15th International Workshop on Laser Ranging, Canberra, Australia, 2008, Vol.2, pp. 321-326.*

What for its updating is being performed?

- To make further this device commercially available, some obsolete electronic components of the A032-ET hardware (which become unavailable) should be replaced by the latter-day ones. This is the main practical reason to update the **A032-ET**, replacing it by the model **A033-ET**.
- **At the same time we wished to improve the event timer precision, retaining the well-tried basic features of the previous model.**

1. Updating the Event Timer A032-ET

1.2. Basics of the method for event timing

Background for the timer advancing is offered by the DSP-based method for event timing which is applied in Riga Event Timers over many years:

- Each input event (pulse edge) is converted to an analog signal by generation of such signal at the time instant defined by the respective input event.
- Then the analog signal is digitised using a typical A/D converter and digitally processed by a special algorithm to estimate its position relative to the periodic sampling pulse sequence.

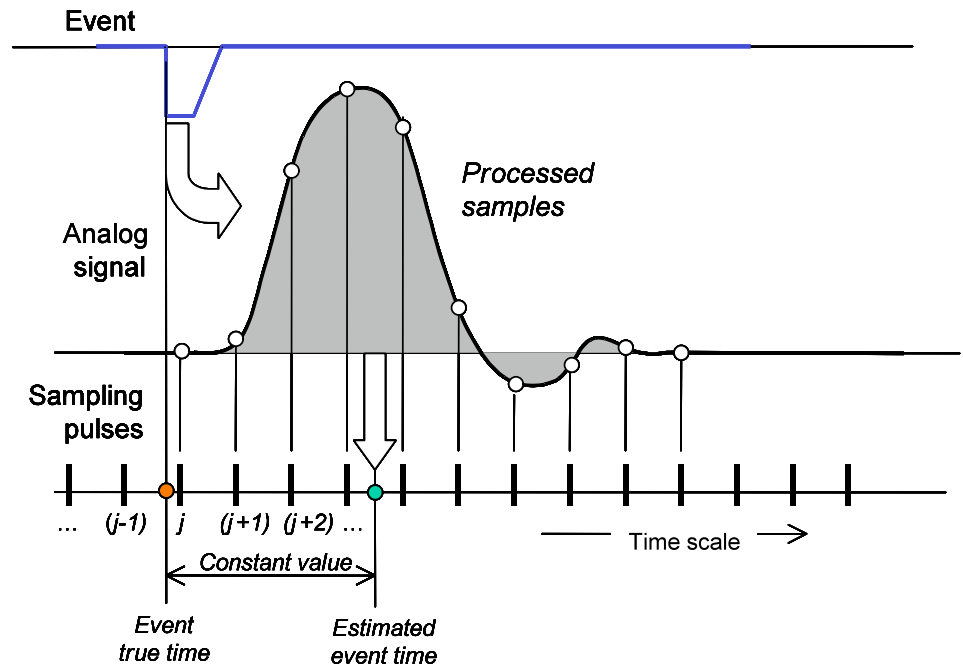

DSP facilities are rapidly progressing allowing considerable progress in DSP-based event timing technology

1. Updating the Event Timer A032-ET

1.3. Achievable resolution

Generally, the more is the number of processed analog signal samples (and greater dead time), the better is achievable resolution of event timing.

Basically we use not more than 4 samples, providing 50-60 ns dead time at 100 MHz ADC sampling rate. In this case the achievable resolution depends on the ADC resolution and internal noises (trigger errors, sampling jitter, induced interferences, etc) as follows:

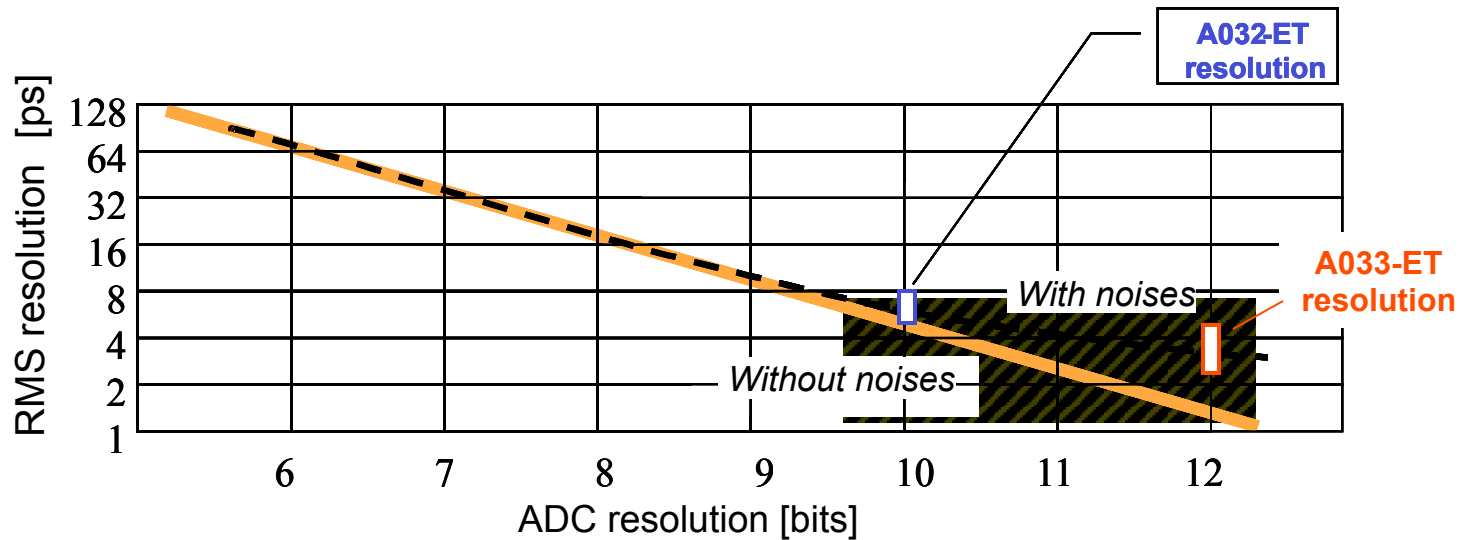

1. Updating the Event Timer A032-ET

1.4. Resolution increasing

In the process of the A032-ET updating, we have replaced the previous 10-bit ADC by 12-bit ADC, minimized internal noises and integral non-linearity by more careful design.

A033-ET vs. A032-ET

<i>Error components (RMS)</i>	A032-ET	A033-ET
Quantizing error	~3.5 ps	~1.1 ps
Internal noise	~2.0 ps	~1.1 ps
Integral non-linearity	~2.6 ps	~1.7 ps
<i>Resulting values (RMS)</i>		
Precision	~4.8 ps	~2.3 ps
Resolution	~6.8 ps	~3.3 ps

Explanation:

Integral non-linearity: systematic errors over interpolation interval

RMS precision: standard deviation of the time-tag

RMS resolution: standard deviation of the difference between two time-tags

1. Updating the Event Timer A032-ET

1.5. Integral non-linearity

The integral non-linearity represents the main component of the errors which restrict final A033-ET precision. Basically it is caused by the impact of input signal on the interpolation process through spurious couplings.

Experimental evaluation of the A033-ET non-linearity

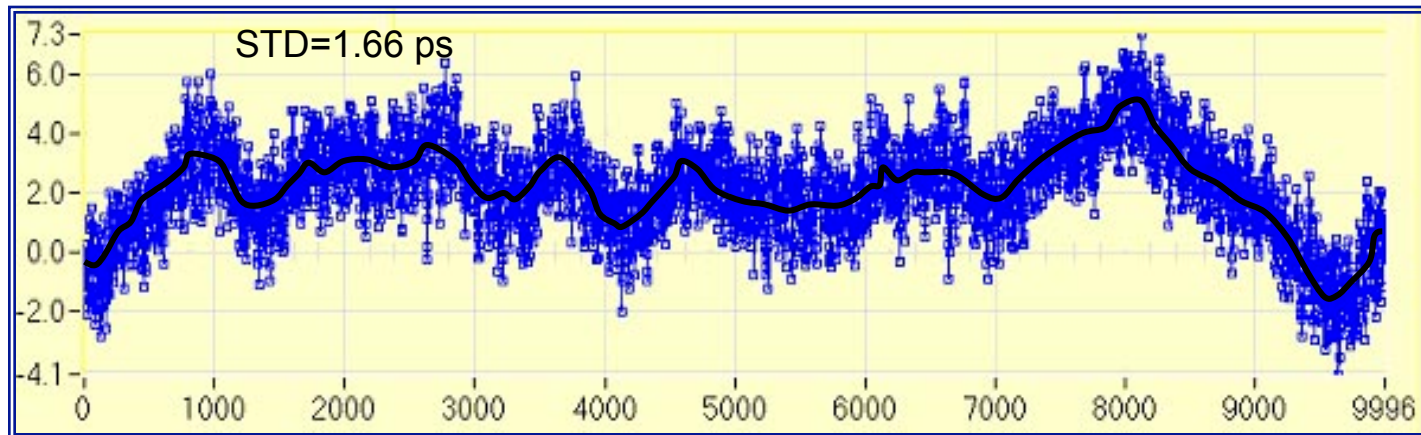

Non-linearity over interpolation interval 10 ns

1. Updating the Event Timer A032-ET

1.6. Achieved result

As a final result of the made efforts, the RMS resolution was increased from the previous 7-8 ps to 3.2-3.5 ps.

Experimental evaluation of the A033-ET resolution

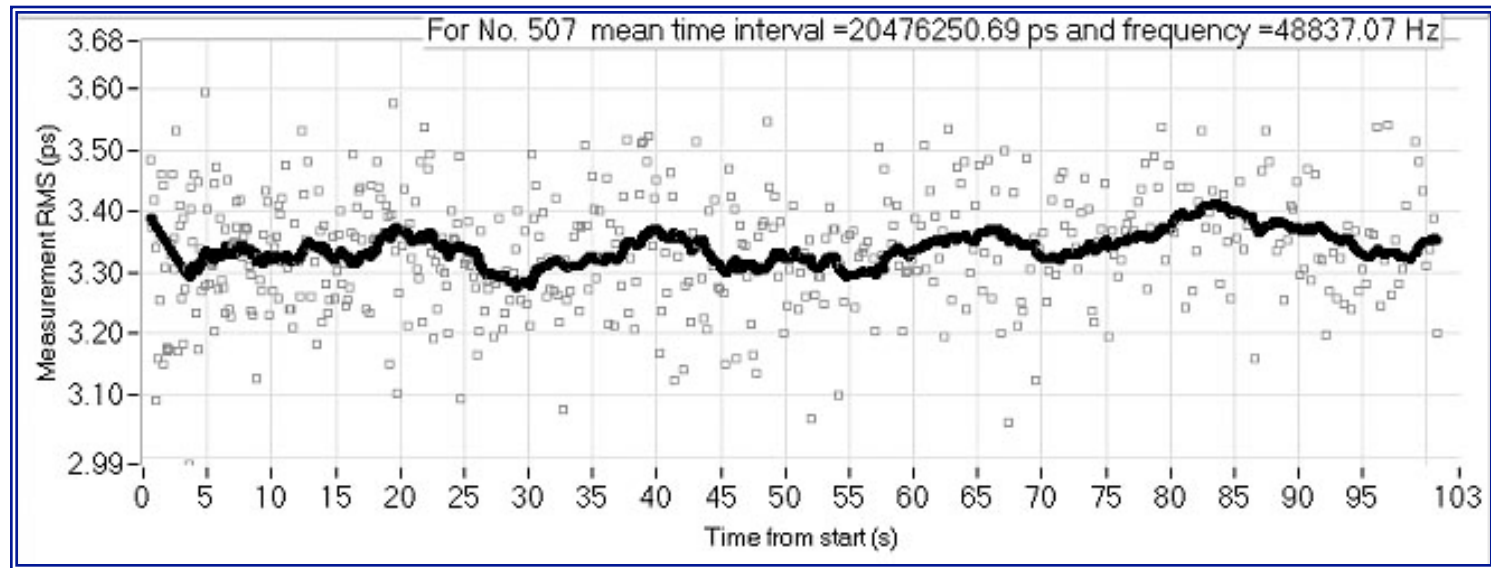

RMS resolution vs. time

Other precision parameters are the same as for the A032-ET.

1. Updating the Event Timer A032-ET

1.7. Conclusion #1

The A033-ET continues the line of Riga Event Timers commercially available on multiple requests. However, to advance the A033-ET from the pilot model to the marketable product, a lot of trivial but time-consuming efforts should be additionally made:

- **Software debugging**
- **Checking of the reproducibility under small-scale production**
- **Updating of user documentation, etc**

We plan to complete such work in the next year.

2. Event Timer Module (ETM)

2.1. Background of the development

Goal:

To provide development and design of various application-specific timing systems by a compact and inexpensive built-in module for high-precision event timing.

The way to achieve the goal:

Retaining well-tried basic principles of event timing, emphasis is made on improvement of DSP algorithms for event time estimation and application of latter-day large-scale integrated chips for hardware design.

2. Event Timer Module (ETM)

2.2. Pilot model design

Main innovations:

- Modified technique of the analog signal shaping and its digital processing
- Using of re-programmable FPGA chip (Cyclone II) for digital operations
- Built-in internal clock synthesis from 10 MHz frequency standard

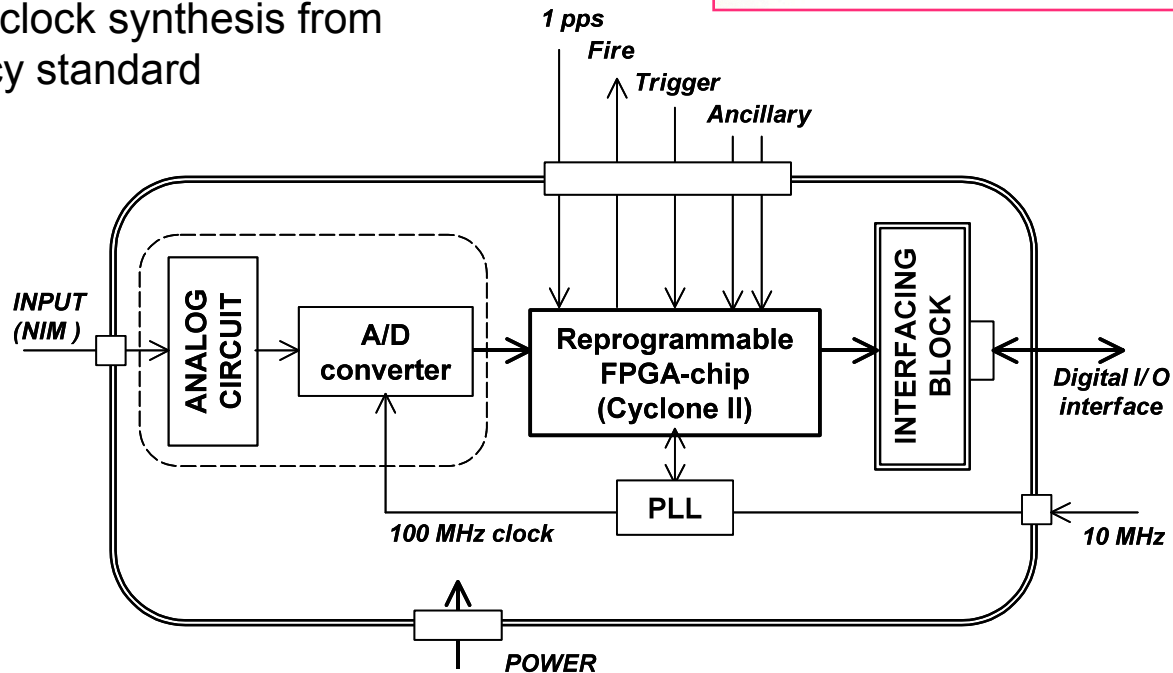
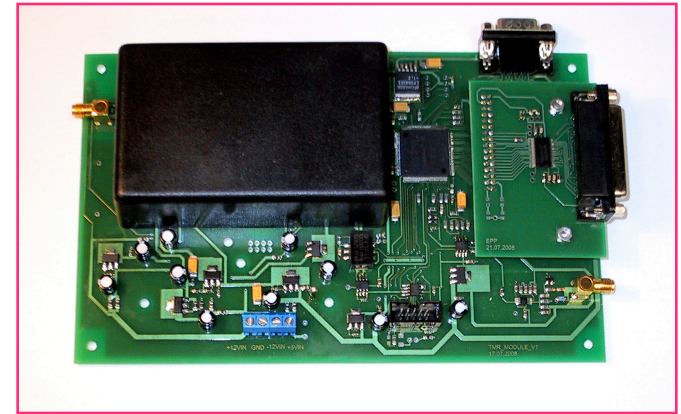

2. Event Timer Module (ETM)

2.3. Performance evaluation

The ETM performance was evaluated in comparison with the A033-ET using the same methods and means of the tests.

Experimental evaluation of the ETM resolution

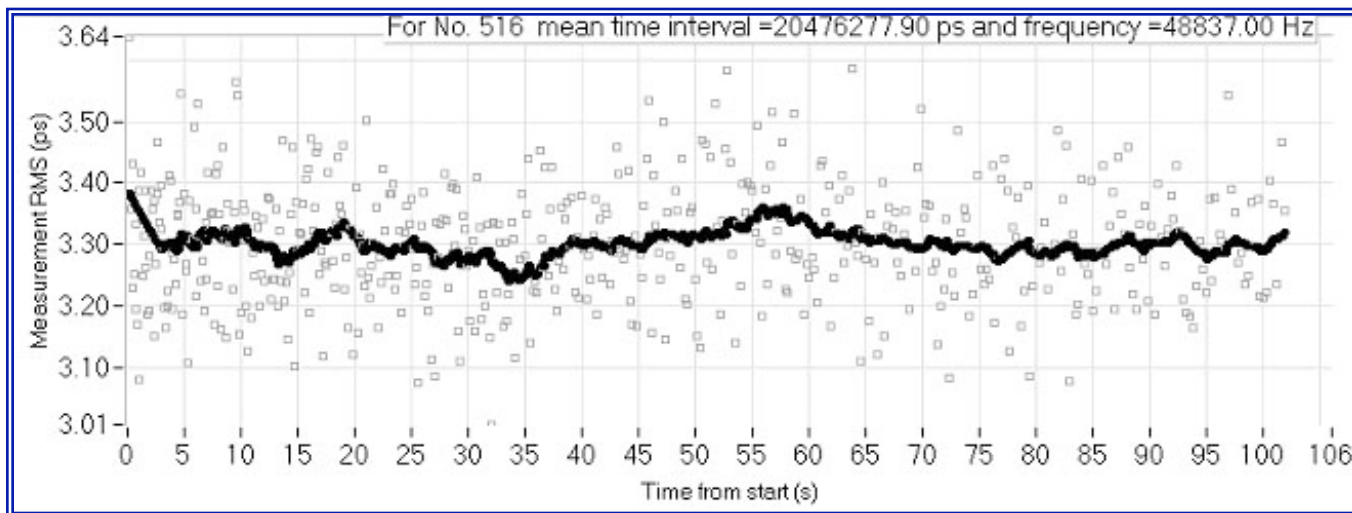

RMS resolution vs. time

There are not noticeable differences between ETM and A033-ET in the achieved resolution and other precision parameters

2. Event Timer Module (ETM)

2.4. Main features (preliminary)

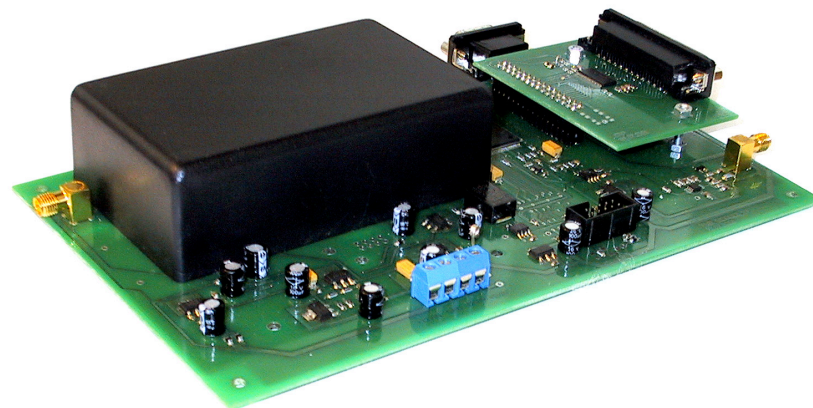

Basic:

- Single input (NIM) for the events being measured
- <4 ps single-shot RMS resolution,
- 40 ns dead time (25 MHz maximum burst rate)
- FIFO depth up to 1K events
- Connection to a computer via selectable port (EPP, USB or other as required)

Additional:

- Input for 1 pps signal from a time standard
- Built-in internal clock synthesis from 10 MHz frequency standard
- Built-in calibration means
- Flexible defining the modes of functioning through re-programming FPGA chip, including ability to internal online programmable gating, fire generation, etc

Physical:

- Dimension of the module card: 130x120 mm
- Power consumption: <6 W

2. Event Timer Module (ETM)

2.5. Conclusion #2

Unlike the A033-ET, conceptually ETM is not considered as a complete ready-to-use product. Actually it represents a flexible platform for creating different options of ET module tailored to specific applications, including space applications.

In addition, ETM is used by us as a technical basis for further development of event timing technology and resolving of various related scientific problems.