



***FEDERAL SPACE AGENCY OF RUSSIA***  
***Federal State Unitary Enterprise***  
***«Scientific Research Institute***  
***for Precise Instruments Engineering»***  
***Saint-Petersburg branch***

***Narrowband holographic filter for SLR***

---

---

---

---

---



- Airborne laser rangefinders
- Lidars
- Spacebased laser communication system
- Satellite laser ranging systems





FEDERAL SPACE AGENCY OF RUSSIA

*Federal State Unitary Enterprise «Scientific Research Institute for Precise Instruments Engineering»  
Saint-Petersburg branch*

- Airborne laser rangefinders
- **Lidars**
- Spacebased laser communication system
- Satellite laser ranging systems







- Airborne laser rangefinders
- Lidars
- Spacebased laser communication systems
- Satellite laser ranging systems

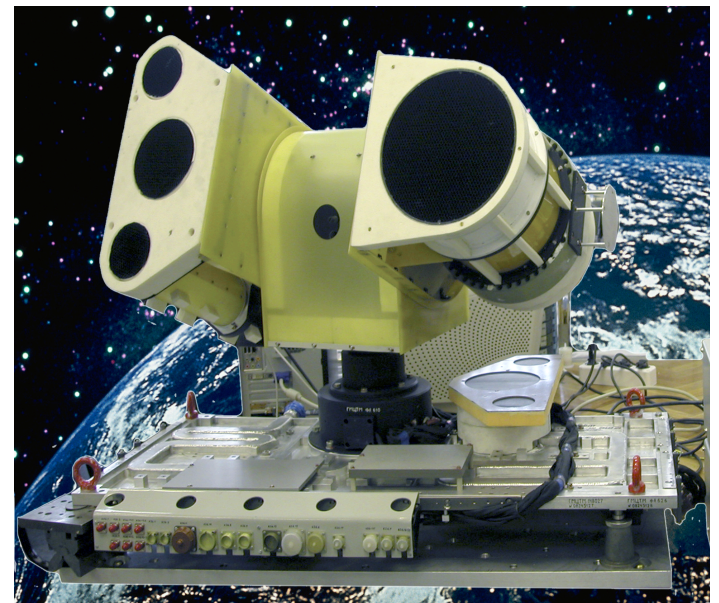
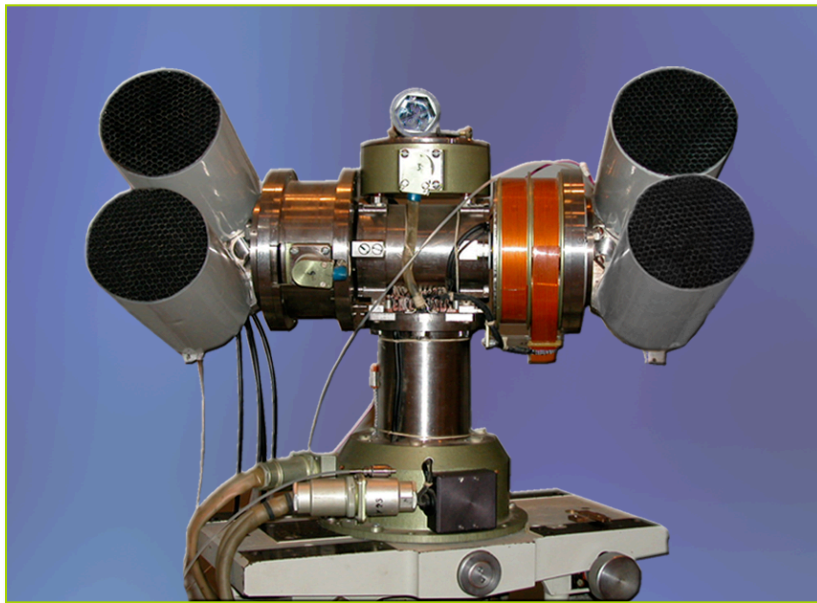





- Airborne laser rangefinders
- Lidars
- Spacebased laser communication system
- **Satellite laser ranging systems**

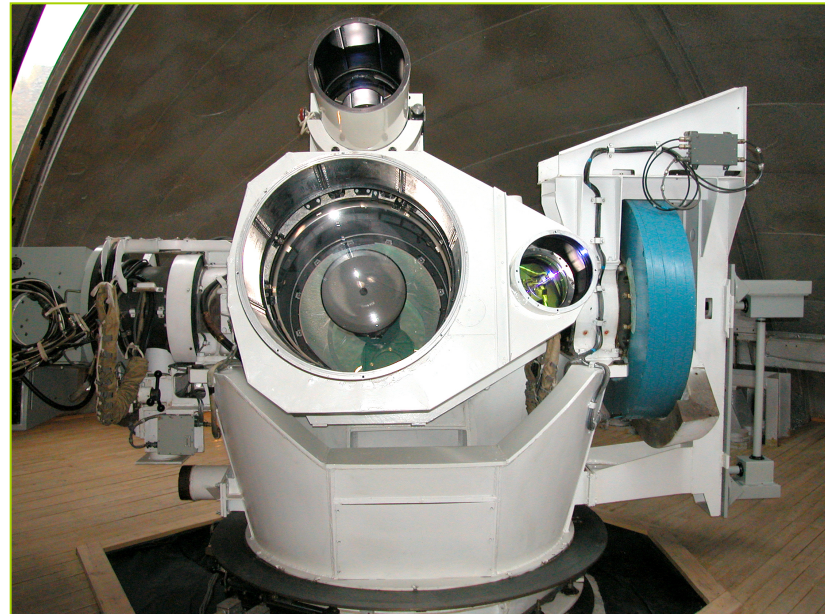



# Narrowband optical selector

## *Requirements*

- Bandwidth  $\sim 100$  pm (1 Å)
- Efficiency  $> 80\%$
- High temporal stability
- Low temperature drift
- Reasonable cost



# Narrowband optical selector

## *Candidates*

- Interference filter
- Faraday filter
- Atomic line filter
- Acoustic-optical filter
- Holographic filter





# Holographic filter

## Basics

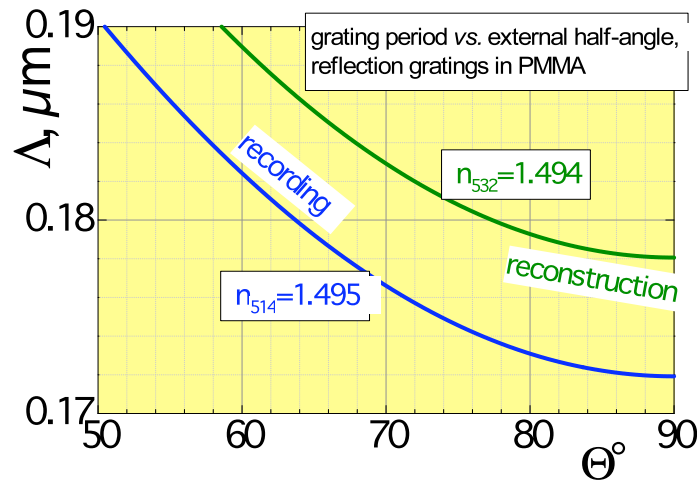
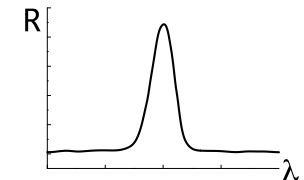
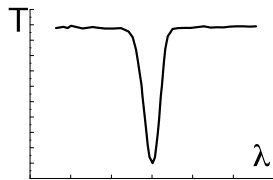
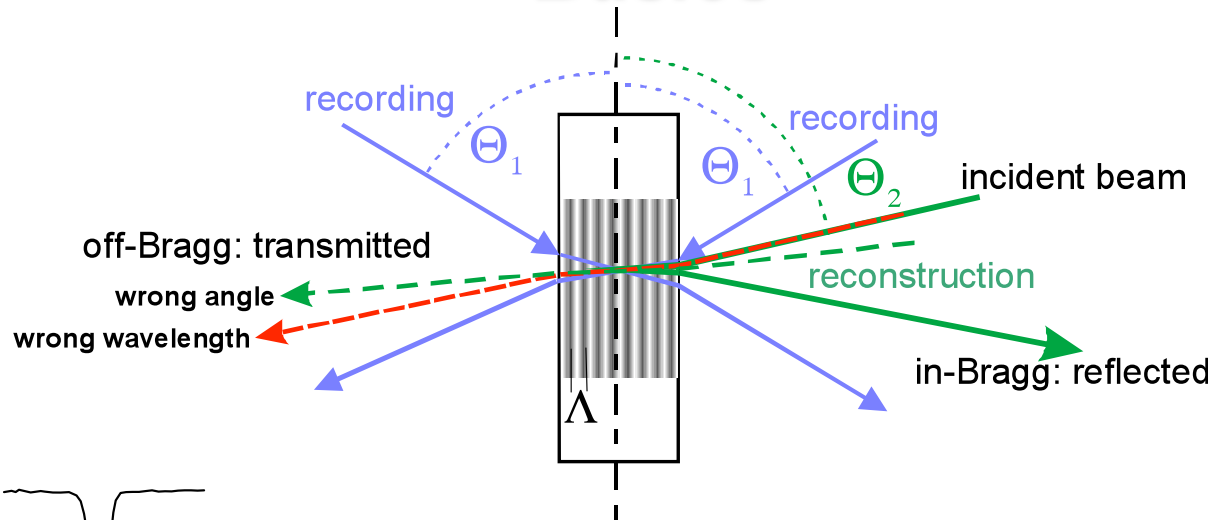

Bragg condition

$$\sqrt{n^2 - \cos^2 \Theta} = \frac{\lambda}{2\Lambda}$$



# Holographic filter

## *Principal stages of manufacturing*

Polymerization

Apodization

Recording

Measurements

Enframing

Final product



# Holographic filter

## Polymerization

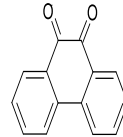
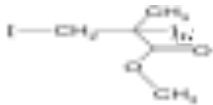

polymethylmethacrylate doped by phenanthrenequinone

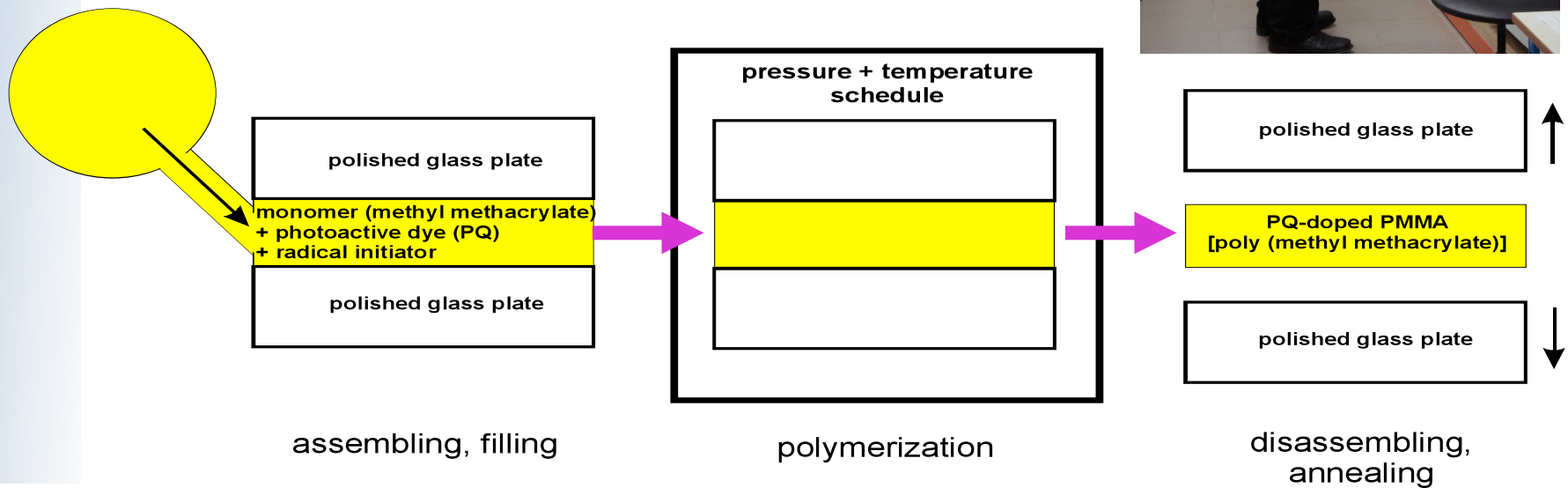
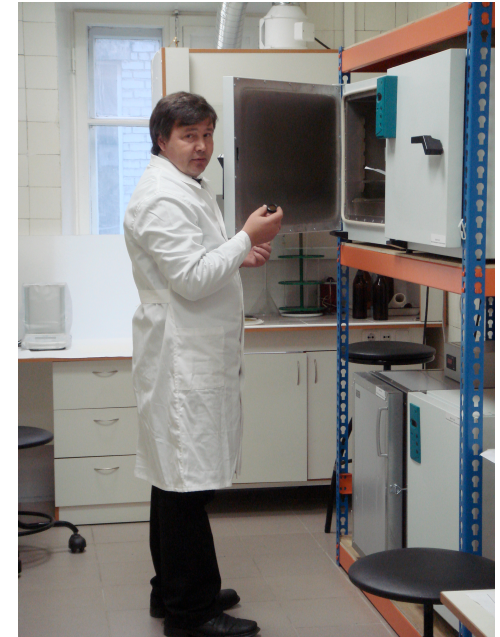





# Holographic filter

## Apodization

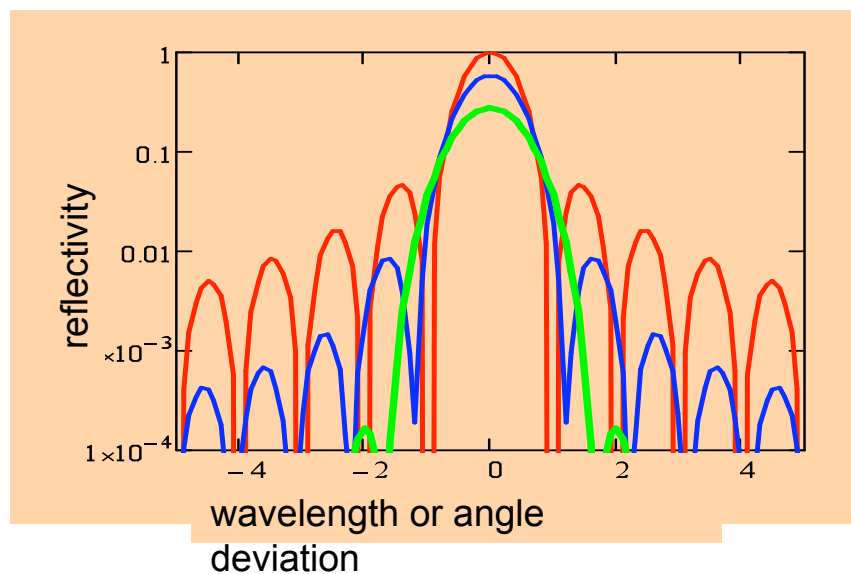
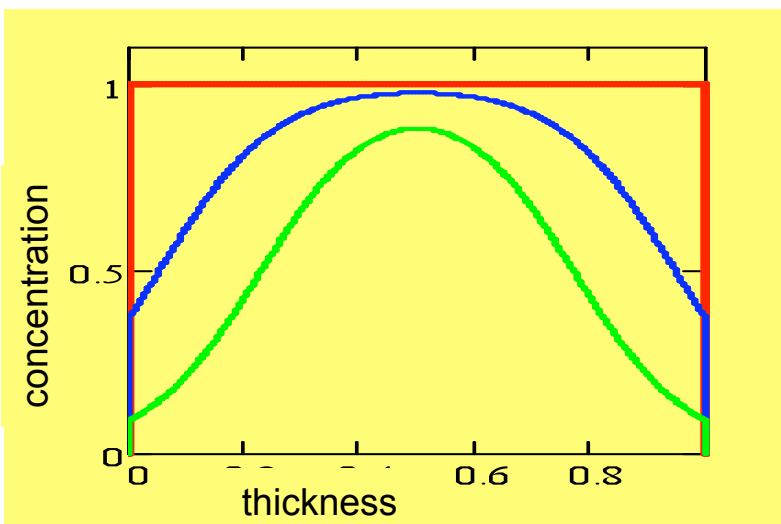
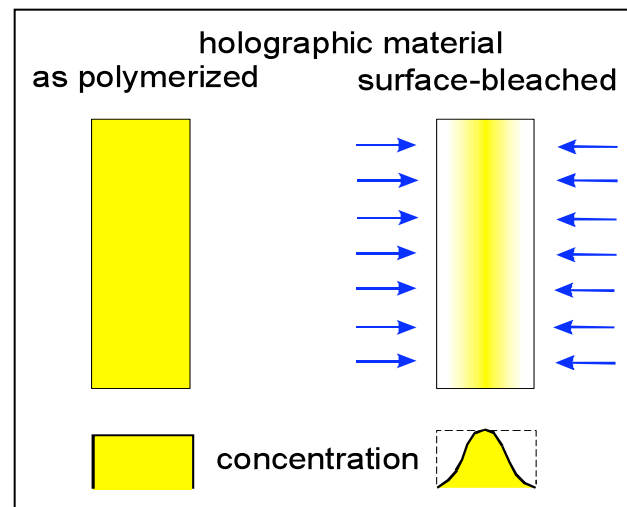
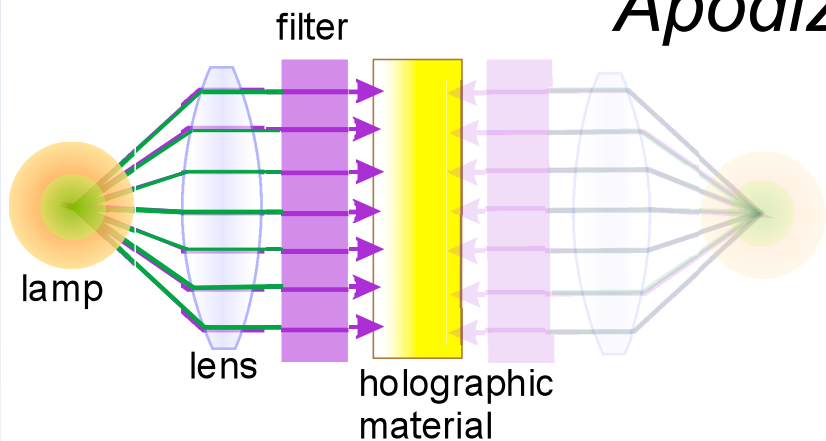



FEDERAL SPACE AGENCY OF RUSSIA

Federal State Unitary Enterprise «Scientific Research Institute for Precise Instruments Engineering»  
Saint-Petersburg branch

# Holographic filter

## Recording

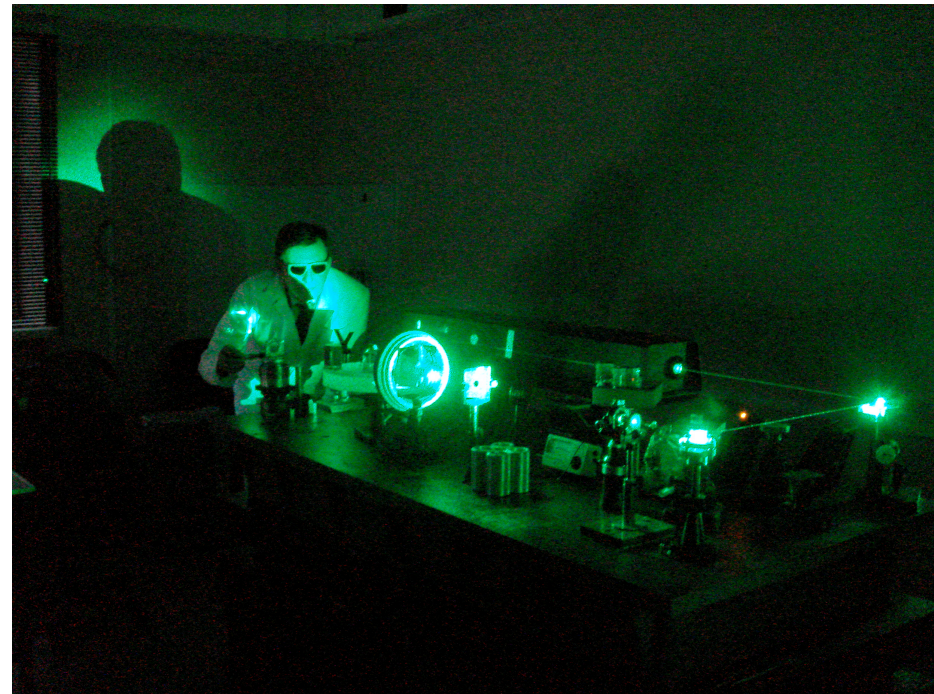
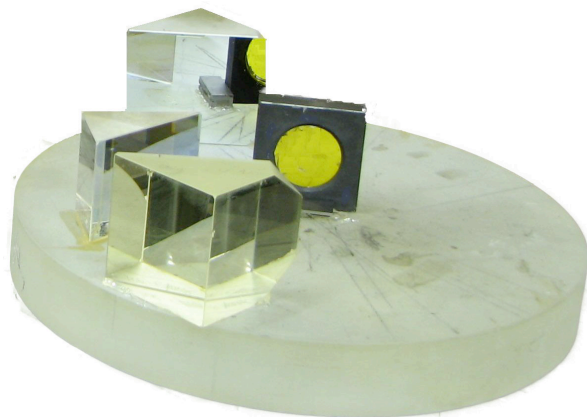
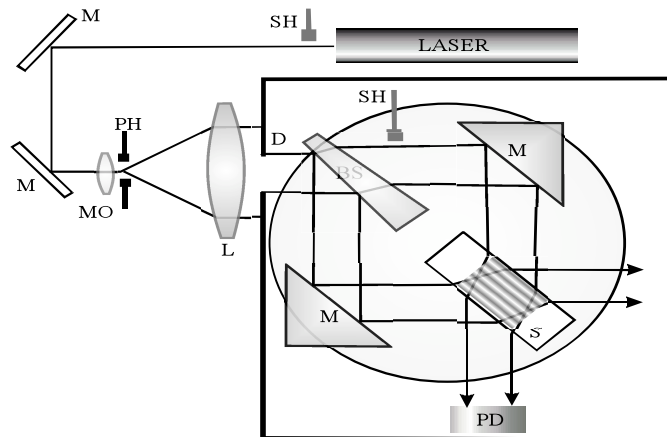



# Holographic filter

## Measurements

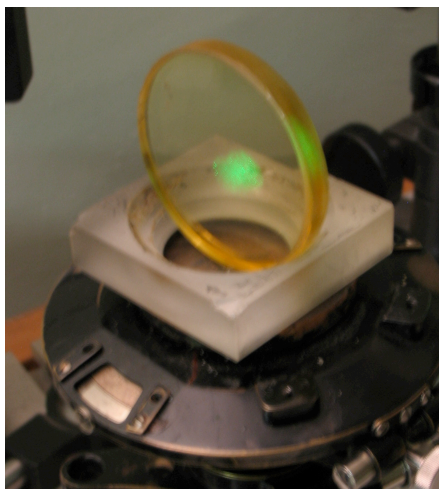
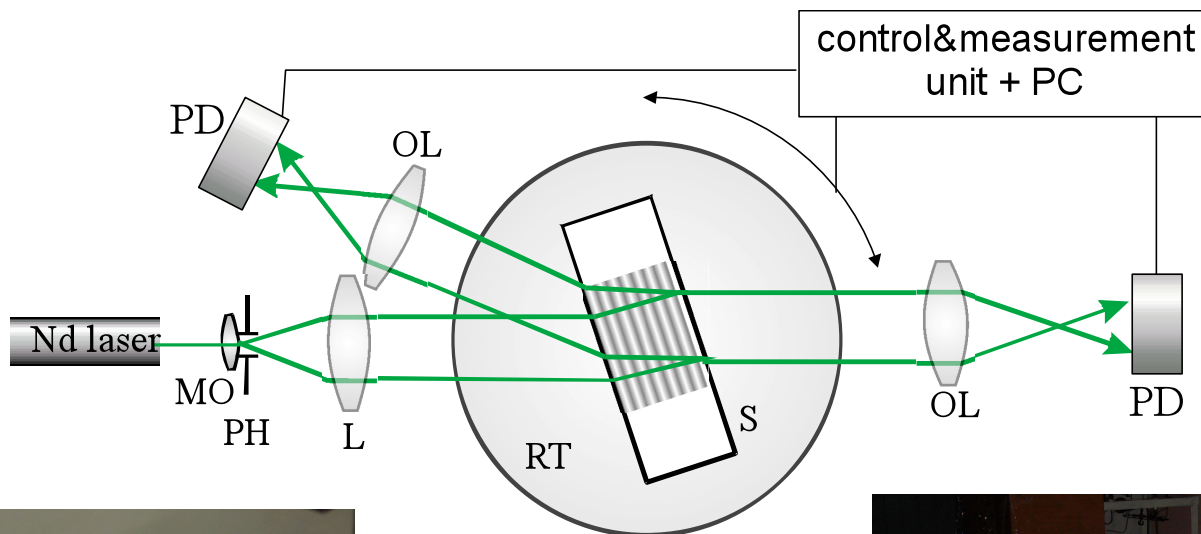





# Holographic filter

## *Final product*

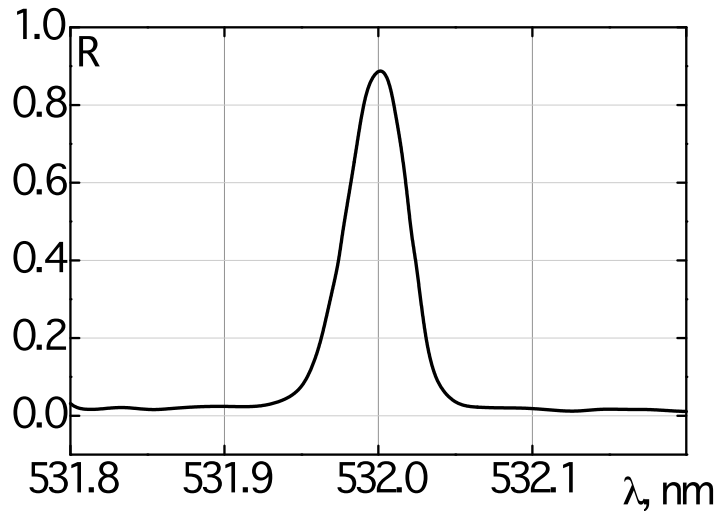

Typical spectrum of selective reflectivity



- spectral selectivity  $\Delta\lambda \sim 1 \text{ \AA}$
- maximum selective reflectivity  $\sim 90\%$
- wavelengths range: visible and NIR regions (typically  $\lambda = 532 \text{ nm}$ )
- thermal wavelength shift  $\sim 0.05 \text{ \AA/K}$ .
- lifetime: years (at moderate temperatures  $< 60 \text{ }^\circ\text{C}$ )
- selective reflection angle  $5 \div 7^\circ$
- angular selectivity  $\Delta\theta = 0.5^\circ$



# Holographic filter

## *Comparison with interference filter*

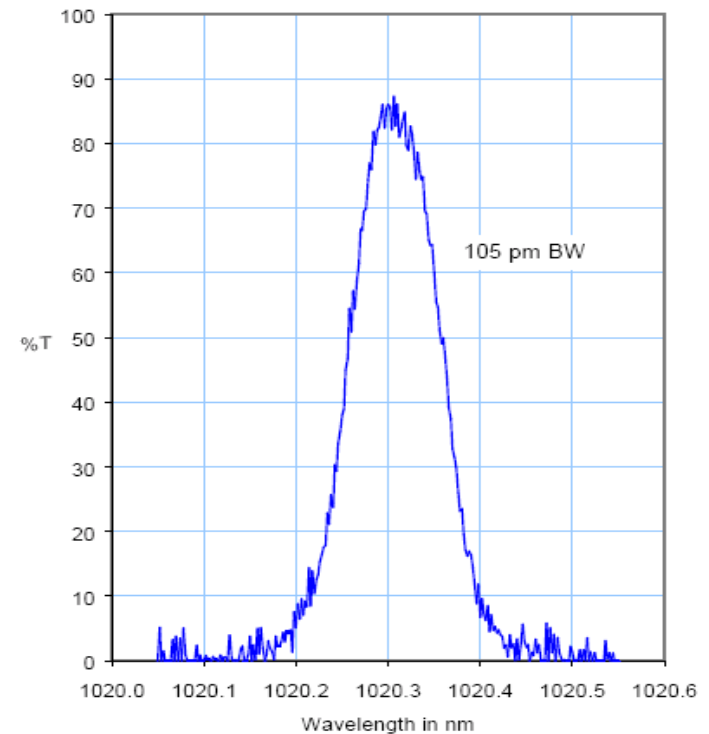
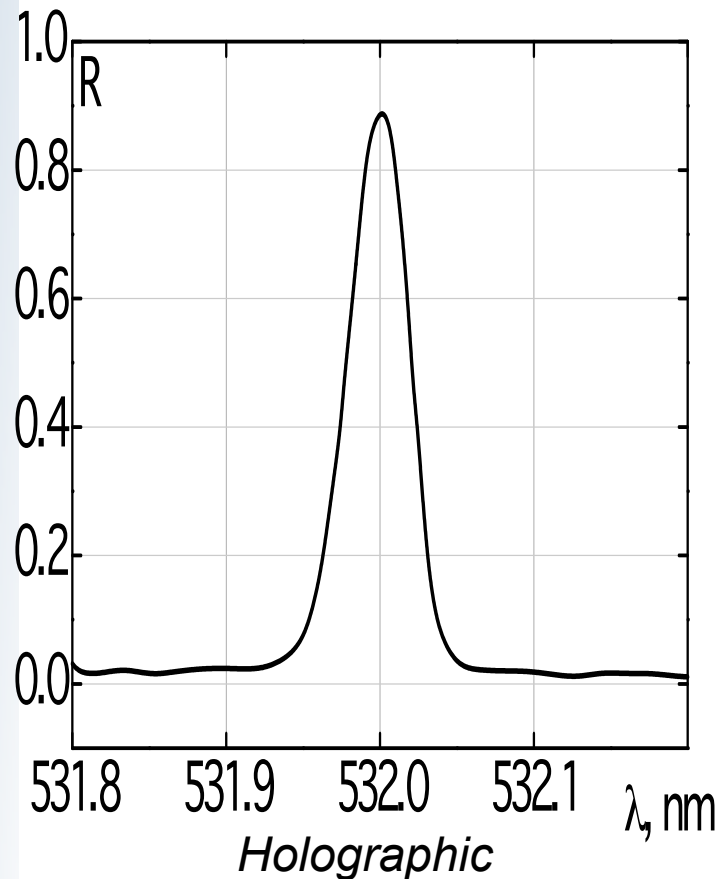

*Interference (Barr<sup>®</sup> Ass. # 000 522-1)*



# Holographic filter

## *Current status*

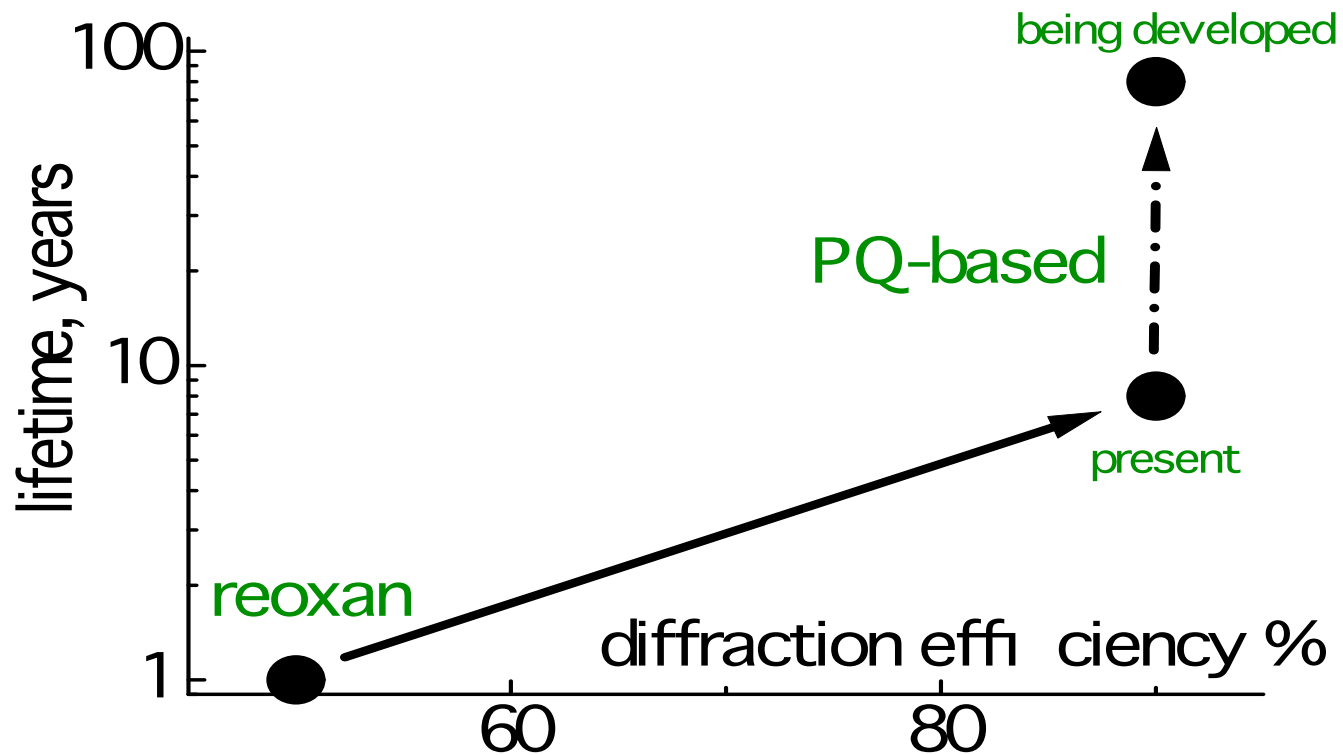





FEDERAL SPACE AGENCY OF RUSSIA

Federal State Unitary Enterprise «Scientific Research Institute for Precise Instruments Engineering»  
Saint-Petersburg branch

# Holographic filter

*Optical element vs. monochromator*



?

