

Introduction

Since September of 2009, Chinese SLR network, including Shanghai SLR station, imported a pico-seconds kHz Laser system from PI Company of USA to perform routine SLR measurement. In recent years, two sets of kHz repetition rate laser with pulse width of 20 ps, 100 ps and the power of ~1W, ~8W respectively and one set of domestic 10kHz laser with power of ~5W and pulse width of 30ps have been in Shanghai SLR station. The measurements to ILRS satellites with slant range of up to 36000km have been performed with precision of center-meter in daylight and night, which is showed in the paper. The 8W laser with the narrow pulse widths is planned for laser ranging to space debris to research the measurement precision and characteristics of objects. The 10kHz repetition rate laser ranging to HEO satellite with distance of ~20000km in daylight and >36000km in night have been firstly performed respectively.

In addition, a 60W laser with pulse width of <10ns and 200Hz repetition rate has been developed by domestic institute and applied for space debris tracking in Shanghai station. A lot of measuring results have been obtained with the excellent performance and reliability.

SLR system (7821)

- Telescope: El-Az, Coude optics;
- Receiving aperture: 60cm, R-C
- Transmit aperture: 21cm, refractor;
- Pointing accuracy: 5" (after star calibration)
- Tracking accuracy: <1"
- Altitude: 99 meters



SLR measurement with High Repetition Rate

Compared to SLR with low repetition rate, high repetition rate SLR has the advantages of larger quantity, better precision, faster acquisition and higher reliability, etc., which has become the prevailing trend of SLR technology development. Routine SLR measurements with kHz repetition rate has been implementing, and the mass of data growing since 2009 by using PI company of US. In 2012-2013, through developing a compact receiving terminal platform to adopt several key techniques (background light filter, kHz laser beam monitoring, receiving FOV of less than 40", arc-second telescope pointing and weak-signal real-time identification), laser ranging to geosynchronous satellites with slant range of 36000km in daytime was also realized by domestic kHz laser, which lift the capability of the Shanghai SLR station.

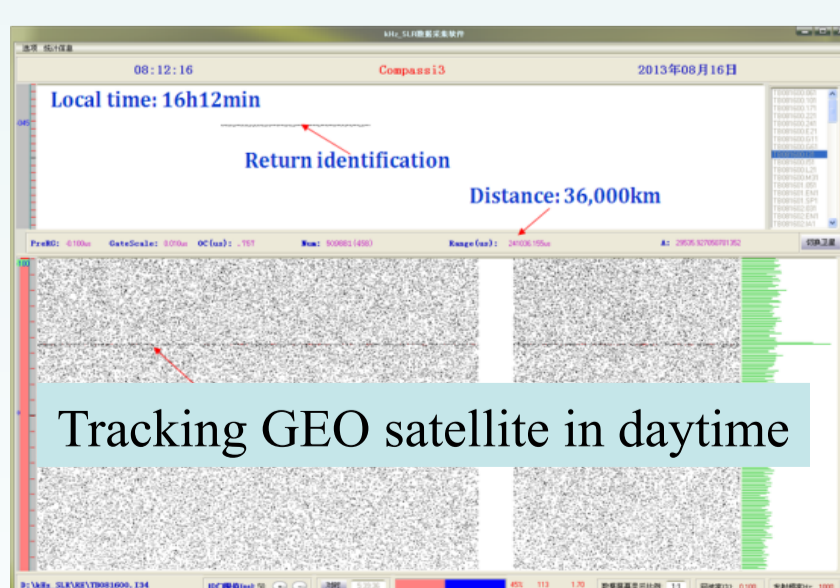
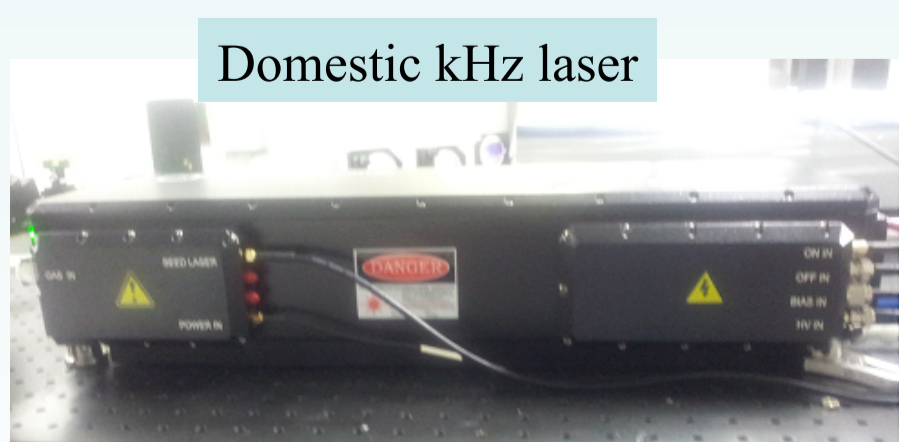
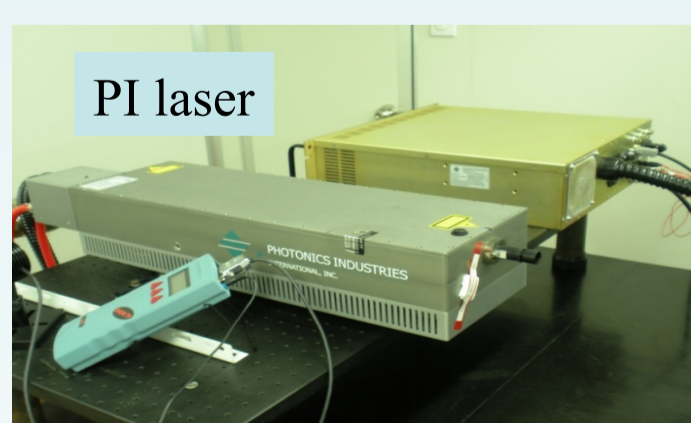

In 2013, Through developing Range Gate Generator with 10kHz repetition, using the detector with low dark noise, improvement of SLR data acquisition/control and post-processing software and adopting domestic 10 kHz repetition

rate laser, the experiments of 10kHz SLR measurements were successfully carried out for the first time, and laser returns from Glonass in daytime and GEO satellites at nighttime were also obtained. The laser returns at the rate of 10 kHz is several times higher than the current kHz SLR systems.

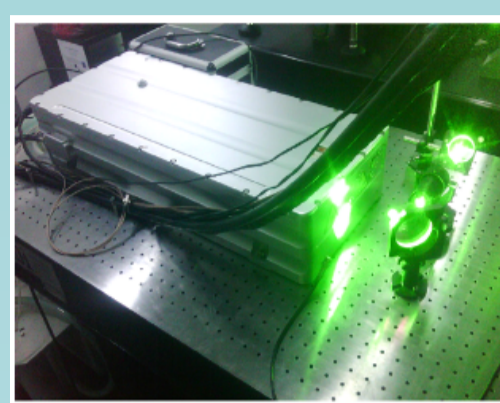

10kHz repetition rate laser

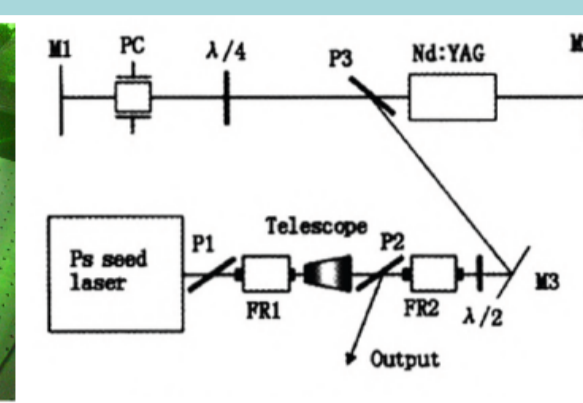

Range residual of 10kHz data

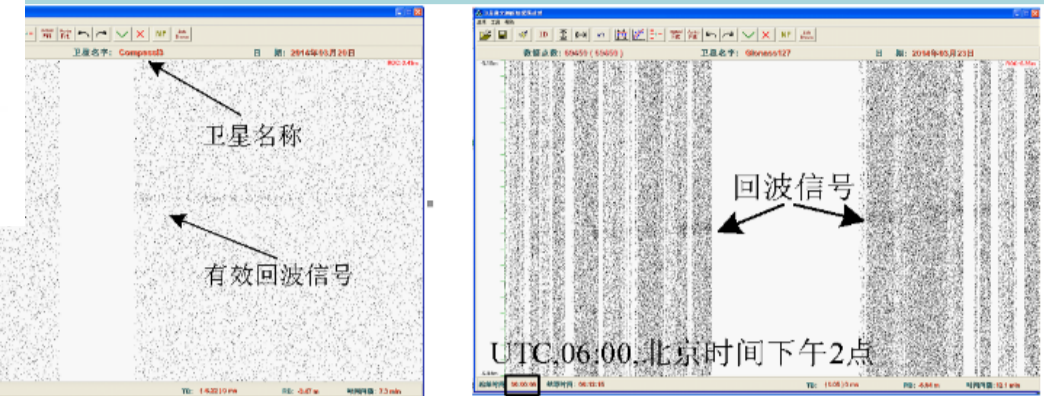

Laser Ranging to Space Debris

The technology of laser ranging to space debris started being investigated in China since 2005, the preliminary space debris laser ranging system with 20Hz repetition rate laser was established based on 60cm SLR system and laser data from space debris were obtained for the first time in China in 2008. Subsequently, the key techniques for laser measurement to space debris have been developing and improving with support of national projects for a few years. Achievements of laser measurement to space debris (>80% success rates, with RCS of >1m², maximal distance of more than 2100 km and minimal RCS of ~ 0.3m²) have been made in 2013 by using the demonstrative 50W laser with 200Hz repetition rate, the low-noise APD detector with quantum efficiency of more than 40% and high-performance spectrum filtering devices.

The new 60W/200Hz/532nm laser system have been developed in 2014 and applied in routine laser observation to space debris and many achievements have been made.

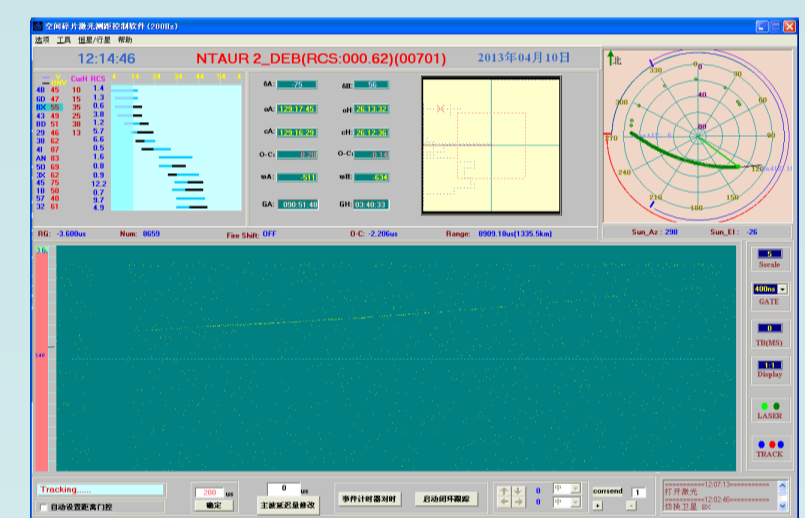

The above results have greatly advanced the state of the art of laser measurement to space debris in China.

To collect a sufficiently large number of returns for laser ranging to far away space targets with weak laser signals, the technology of multi-receiving telescopes has been put forward. In 2012, an experimental measurement system based on the 60cm SLR system and 1.56m astronomical telescope at a distance of about 50m in the Shanghai SLR station was established to provide the platform for research on the multi-receiving telescope technology. After resolving some key technical issues (e.g. range gate control synchronization, calibrating system delays, and laser data processing for the multi-receiving telescopes), laser ranging experiments to satellites with retro-reflectors and space debris were successfully performed. The technical feasibility of increasing the capability of echo detection was also confirmed. The multi-receiving telescopes technology will be a novel effective means for laser ranging to space debris.

Summary

Shanghai SLR station has been implementing the routine measurements to all the ILRS satellites by using kHz SLR in daytime and nighttime, and firstly realize and apply the 10kHz SLR technology. The routine laser observations to space debris have been performed by a domestic high power laser system with the maximal distance of over 2100km and the minimal RCS of 0.3m², and the research on laser ranging to farther and small space debris based on multi-receiving telescope technology are underway.