

The 2007 Yarragadee (Moblas 5) Local Tie Survey

GEOSCIENCE AUSTRALIA
RECORD 2007/19

by

A. Woods, R. Ruddick¹

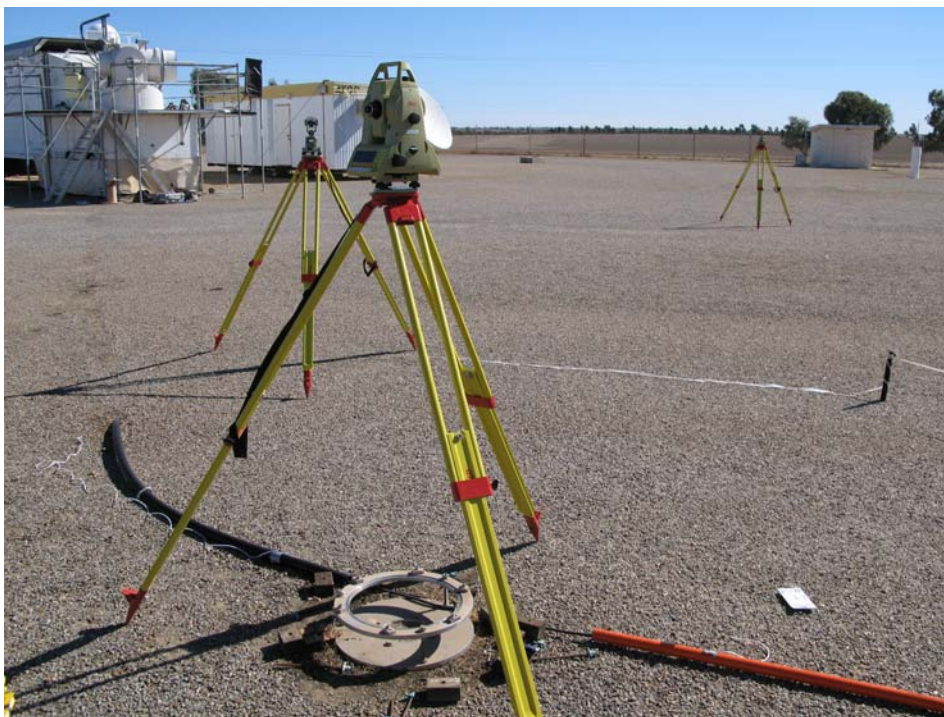

Australian Government
Geoscience Australia

¹ National Geospatial Reference Systems, Geohazards and Earth Monitoring Division, Geoscience Australia GPO Box 378
Canberra ACT 2601

Department of Industry, Tourism & Resources

Minister for Industry, Tourism & Resources: The Hon. Ian Macfarlane, MP

Parliamentary Secretary: The Hon. Bob Baldwin, MP

Secretary: Mark Paterson

Geoscience Australia

Chief Executive Officer: Dr Neil Williams

© Commonwealth of Australia, 2007

This work is copyright. Apart from any fair dealings for the purpose of study, research, criticism, or review, as permitted under the *Copyright Act 1968*, no part may be reproduced by any process without written permission. Copyright is the responsibility of the Chief Executive Officer, Geoscience Australia. Requests and enquiries should be directed to the **Chief Executive Officer, Geoscience Australia, GPO Box 378 Canberra ACT 2601.**

Geoscience Australia has tried to make the information in this product as accurate as possible. However, it does not guarantee that the information is totally accurate or complete. Therefore, you should not solely rely on this information when making a commercial decision.

ISSN 1448-2177

ISBN 978-1-921236-64-8

GeoCat # 65381

<p>Bibliographic reference: Woods, A., Ruddick, R., 2007. The 2007 Yarragadee (Moblas 5) Local Tie Survey. Geoscience Australia, Record 2007/19. 27pp.</p>

Contents

Executive Summary	iii
Introduction	iv
1. Site Description	1
2. Instrumentation	1
2.1 Tacheometers, EDM, Theodolites.....	1
2.1.1 Description.....	1
2.1.2 Calibration results	2
2.1.3 Auxiliary equipment.....	3
2.2 GPS units.....	3
2.3 Levelling	3
2.3.1 Levelling instruments.....	3
2.3.2 Levelling rods	4
2.3.3 Checks carried out before measurements.....	4
2.4 Tripods	4
2.5 Forced centring devices.....	4
2.6 Targets, reflectors.....	4
3. Measurement Setup	4
3.1 Ground network	4
3.1.1 Listing	4
3.1.2 Map of network.....	6
3.2 Representation of reference points.....	7
3.2.1 VLBI	7
3.2.2 SLR	7
3.2.3 GPS	10
3.2.4 DORIS.....	10
3.2.5 GLONASS	11
4. Observations	11
4.1 Conventional Survey	11
4.1.1 Network Survey	11
4.2 Levelling	11
4.3 SLR	13
4.3.1 Azimuth Observations.....	13
4.3.2 Elevation Observations	14
4.4 DORIS and MET Station	15
4.5 GPS	15
4.6 General Comments.....	15
5. Data Analysis and Results	16
5.1 Data Pre-Processing	17
5.1.1 Levelling	17
5.1.2 Reuger Heighting	17
5.1.3 Network Survey	17
5.1.4 DORIS Observations.....	17



5.2 Classical Geodetic Adjustment	17
5.2.1 Topocentric Coordinates and Covariances.....	18
5.2.2 Correlation Matrix.....	18
5.2.3 Reference Temperature	18
5.3 IVP Determination	19
5.4 Transformation.....	19
5.5 SINEX file Generation	19
5.6 GPS	20
5.7 Additional Parameters.....	20
5.8 Discussion of Results	21
5.9 Comparison with Previous Surveys	23
6. Planning Aspects	24
7. References	26
7.1 Name of person responsible for observations	26
7.2 Name of person responsible for analysis.....	26
7.2.1 Data Reduction and Classical Adjustment	26
7.2.2 GPS Analysis, IVP Determination, Alignment and SINEX.....	26
7.3 Location of observation data and results archive	27

Executive Summary

THE 2007 YARRAGADEE (MOBLAS 5) LOCAL TIE SURVEY

The integrity and strengths of multi-technique terrestrial reference frames such as ITRF2005 depend on the precisely measured and expressed local tie connections between space geodetic observing systems at co-located observatories. A local tie survey was conducted at the Yarragadee (Moblas 5) Satellite Laser Ranging (SLR) observatory, on the Yatharagga property in Western Australia, in May/June of 2007. The aim of the survey was to precisely measure the local terrestrial connections between the space-based geodetic observing systems co-located at the observatory, which include GPS, GLONASS, SLR and DORIS. In particular, this report documents the indirect determination of the SLR invariant reference point (IVP). Geoscience Australia has routinely performed classical terrestrial surveys at the Moblas 5 SLR observatory, including surveys in 1992, 1999, 2001 and 2003. Precise levelling and traverse measurements were made between the permanent survey monuments surrounding the SLR observatory. These survey marks were monitored to ensure their stability as part of a consistent, stable terrestrial network from which local tie connections were made to the SLR IVP and other observing systems. The relationship between points of interest included the millimetre level accurate connections and their associated variance covariance matrix, providing an un-broken contribution of the Yarragadee (Moblas 5) observatory to future terrestrial reference frames and other scientific outputs.

In this report, observational and analysis techniques are reviewed and results are given. In particular, the 2007 survey results are compared with those obtained at Yarragadee in 2003.

Figures and portions of this text have been copied with the authors permission from:

Dawson, J., Sarti, P., Johnston, G. and Vittuari, L., 2007. Indirect Approach to Invariant Point Determination for SLR and VLBI Systems: An Assessment, *Journal of Geodesy, Special Issue VLBI*, June 2007, Vol 81, No. 6-8.

Johnston, G. and Dawson, J., 2004. The 2003 Yarragadee (Moblas 5) Local Tie Survey. *Geoscience Australia Record*, 2004/19, 27pp. Available online: http://www.ga.gov.au/image_cache/GA5651.pdf

Johnston G., Dawson J., Twilley B. and Digney P., 2000. Accurate Survey Connections between Co-located Space Geodesy Techniques at Australian Fundamental Geodetic Observatories, *Australian Surveying and Land Information Group (AUSLIG) Geodesy Technical Report 3*, available online: http://www.ga.gov.au/image_cache/GA5035.pdf



Introduction

This report is not meant to serve as a manual for precision geodetic local tie surveys and it largely assumes that the reader has an understanding of the basic concepts of geodetic surveying. Furthermore, this report does not detail or justify the approach taken, but merely reports the results of each major computation step. However, for completeness, the steps in the approach used to observe and derive the local tie connection are as follows:

- *The calibration of all geodetic instrumentation including: total station instruments, levelling staffs, fixed height mounts, and reflectors (targets);*
- *High precision geodetic levelling (EDM-Height traversing) between survey marks surrounding the observatory;*
- *Observation of a horizontal geodetic network by application of terrestrial geodetic observations, including distances and directions to survey marks in the vicinity of the observatory;*
- *Observation to a number of targets positioned on the SLR during rotational motion about each of the systems' independent axes (azimuth and elevation). This included zenith angle observations to a staff on a levelled survey mark in the vicinity for precise height of instrument determination;*
- *Reduction of terrestrial geodetic observations, including corrections to observations for instrument and target bias, set reduction and atmospheric effects;*
- *Classical geodetic least squares (minimum constraint) adjustment of all terrestrial geodetic observations, resulting in terrestrial only coordinate estimates and their associated variance-covariance matrix (in the local system) of the geodetic network marks and targets positioned on the SLR;*
- *Invariant reference point (IVP) modelling and estimation as well as estimation of the axes of rotation and associated system parameters such as axis orthogonality and the offset of the axes. This includes readjustment of the terrestrial only network;*
- *Transformation (translation and rotation only) of the readjusted terrestrial network and computed IVP coordinate variance-covariance matrix into a global reference frame including a geocentric variance-covariance matrix (estimated and a priori);*
- *Reduction of the complete solution to stations of primary interest and output of a SINEX format solution file.*



1. Site Description

The Yarragadee (Moblas 5) Satellite Laser Ranging (SLR) facility is located 100km south east of Geraldton, Western Australia, on the Yatharagga property. The SLR is co-located with other observing systems including GPS, GLONASS and DORIS. There are a number of survey monuments and pillars within the observatory compound which serve as calibration pillars and reference marks for the SLR, and instrument locations for the GPS, GLONASS and DORIS. It is from this network of survey marks and pillars that terrestrial connections are made to space based observing systems, in particular the SLR.

Table 1: List of globally important survey marks at the Moblas 5 SLR observatory.

Local Designation	Global/IERS Designation
RM4	YAR2 50107M004 YARRAGADEE IGS GPS GM
AU053 (or AU53)	YARR 50107M006 YARRAGADEE GLONASS GM
DON95	7090 50107M001 YARRAGADEE SLR GM
DORIS GM	YARM 50107M005 YARRAGADEE YARB GM
DORISP	YASM 50107M007 YARRAGADEE DORIS/YASM
IVP	YIVP 50107S007 YARRAGADEE SLR IVP
DORISN	YASB 50107S011 YARRAGADEE DORIS/YASB
YAR3	YAR3 50107M008 YARRAGADEE GPS/GLONASS GM

2. Instrumentation

2.1 Tacheometers, EDM, Theodolites

2.1.1 Description

Leica TCA2003 Total Station, SN 439124.

Specification:

- EDM (infrared) distance standard deviation of a single measurement (DIN 18723, part 6):
1mm + 1ppm;
- Angular standard deviation of a mean direction measured in both faces (DIN 18723, part 3):
0.15mgon (0.49").

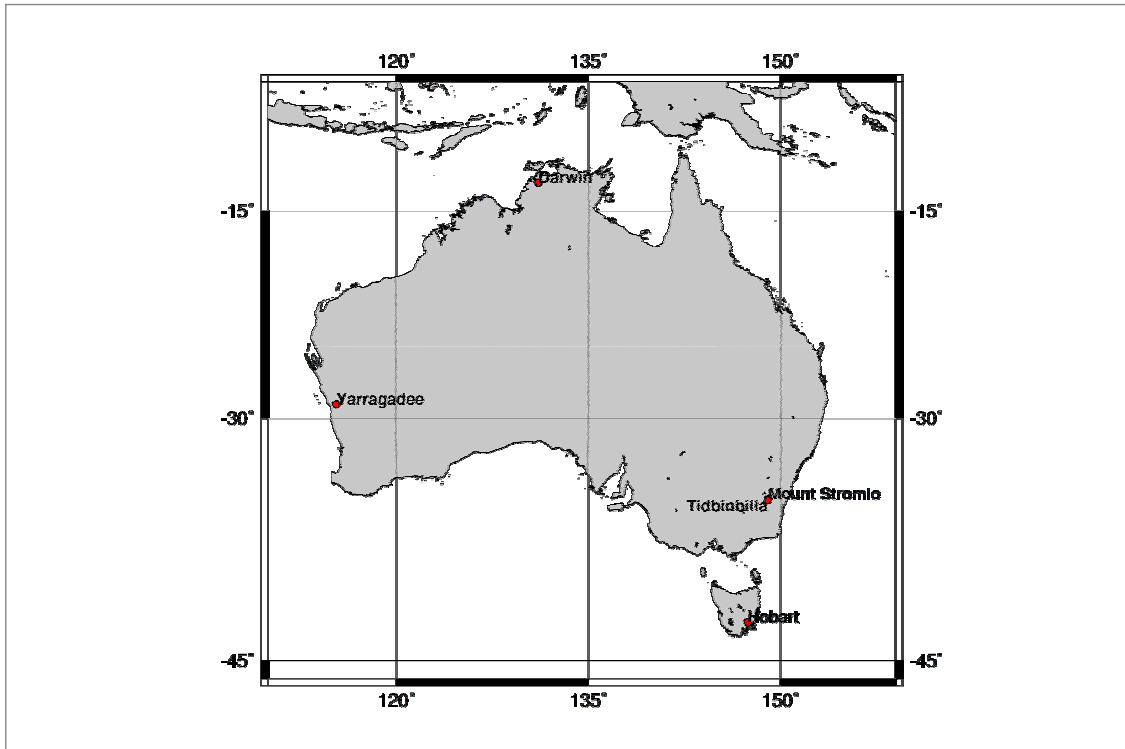

Figure 1: Moblas 5 (Yarragadee) Satellite Laser Ranging (SLR) Observatory. The co-located observatory includes SLR, GPS, DORIS and GLONASS systems.

2.1.2 Calibration results

Calibration results presented here refer to 2007 survey equipment. For previous survey calibration results refer to Johnston and Dawson (2004) and Johnston et al. (2001). The Leica TCA2003 Total Station was serviced by C. R. Kennedy (Sydney, Australia) in April 2007. The total station calibration was performed by Leica Geosystems AG Heerbrugg, Switzerland. Inspection date: 10th December 2001:

- EDM (Infrared) distance standard deviation: $m_0 = 0.2\text{mm}$ (Distances from 19.5m to 501.5m). Distance linearity: $\pm 0.3\text{mm}$ (Distances from 2.25m to 120m);
- Angular standard deviation horizontal: 0.09 mgon (0.29'') and vertical: 0.09 mgon (0.29'').

Reflector calibration:

- Additive constant for Leica GPH1P precision prism is -34.4mm which is applied directly in the total station. All prisms calibrated on a tripod baseline at Geoscience Australia, Symonston in May 2007. Approximate prism corrections of 0.0mm applied to observations in data processing.
- Leica Precision Micro-Prisms were calibrated at Geoscience Australia in May 2007. Approximate prism corrections of +17.8mm applied to observations in data processing.
- Additive constant for Leica Retro-reflective tape is 0.0mm from front face. Correction of +34.4mm applied to observations in data processing.



Staff calibration:

- The staff used for instrument heighting (refer section 4.1) was compared against a calibrated invar staff by Geoscience Australia.

2.1.3 Auxiliary equipment

Meteorological observations of temperature, pressure and humidity were recorded using a 4000 Pocket Weather Tracker (SN: 538391). In addition, meteorological data was available from the meteorological measurement system on site.

2.2 GPS Units

GPS observations were made at four monuments in the terrestrial network, namely YAR2 (permanent IGS station), YARR (permanent IGLOS station), AU063 and AU064. Unfortunately, the data collected at YARR was unavailable at the time of data processing, so baselines were only computed between the three GPS sites (YAR2, AU063, AU064). The GPS analysis was undertaken within the International Terrestrial Reference Frame 2000 (ITRF2000) and was used to align the local terrestrial network to ITRF2000.



Figure 2: Left: Moblas 5 (Yarragadee) permanent IGS GPS station (50107M004), permanent IGLOS GLONASS station (50107M006) and new YAR3 GPS/GLONASS station (50107M008).

2.3 Levelling

2.3.1 Levelling instruments

Leica TCA2003 Total Station, SN 439124.

Specification:

- EDM (infrared) distance standard deviation of a single measurement (DIN 18723, part 6):
1mm + 1ppm;
- Angular standard deviation of a mean direction measured in both faces (DIN 18723, part 3):
0.15mgon (0.49”).



2.3.2 Levelling Rods

Fixed height stainless steel rod (approximately 1.5m in height) and fixed height stainless steel stub (approximately 0.2m in height) with Leica bayonet mount for mounting precision prism (refer to section 4.2 for technique details).

2.3.3 Checks carried out before measurement

Multi-set (repetition), dual face observations were taken to each target eliminating collimation effects. The offset in length between the 1.5m pole and the 0.2m stub used on pillars was determined by observing both on a low mark and calculating the offset. No other pole calibration was required.

2.4 Tripods

Leica GST20/9 heavy duty fixed timber tripod.

2.5 Forced Centering Devices

Wild Zenith Nadir Plummet (ZNL).

2.6 Targets, Reflectors

Total station target kits included:

- Leica GDF21 Tribrach;
- Leica GZR3 prism carrier with optical plummet;
- Leica GPH1P precision prism.
- Leica precision mini-prism.

3. Measurement Setup

3.1 Ground Network

3.1.1 Listing

The following sites were included in the ground network:

Moblas 5 IVP (YIVP): Domes 50107S007. The intersection of the azimuth axis with the common perpendicular of azimuth and elevation axis of the Yarragadee Moblas 5 Satellite Laser Ranging telescope.

AU053 (YARR): Domes 50107M006. The intersection of the top of the stainless steel plate with the vertical axis of a 5/8" ϕ Whitworth threaded stainless steel spigot. This pillar plate is set at ground level and is embedded in concrete to a depth of 400mm. The GPS – Glonass antenna currently occupies this monument.

YAR3: Domes 50107M008. Concrete pillar approximately 0.3m diameter. The mark refers to the intersection of the top of the stainless steel plate with the vertical axis of a 5/8" ϕ Whitworth threaded stainless steel spigot. The new GPS/Glonass antenna currently occupies this monument.



DON95: Domes 50107M001, CDP 7090. Punch mark in a circular brass plaque 0.080m in diameter set in concrete. The plaque is inscribed “Australian Survey Office Survey Mark” and is stamped DON 95. This is the primary reference point for the Moblas 5 SLR system.

DON95 RMI: Punch Mark in brass rod, 0.010m diameter, set in concrete. A brass plaque stamped “RM1” is set in concrete nearby. The Latvian PSLR system (CDP 7847, Domes 50107S009) was temporarily positioned over this mark. The eccentricities to the PSLR are not available as part of this survey.

DON95 RM2: Punch Mark in brass rod, 0.010m diameter, set in concrete. A brass plaque stamped “RM2” is set in concrete nearby.

DON95 RM3: Punch Mark in brass rod, 0.010m diameter, set in concrete. A brass plaque stamped “RM3” is set in concrete nearby.

DON95 RM4 (YAR2): Domes 50107M004, AU029. Punch Mark in brass rod, 0.010m diameter, set in concrete. A brass plaque stamped “RM4” is set in concrete nearby. This mark constitutes the permanent IGS GPS station.

DON38: Mark is a “Lands and Surveys” pre cast SSM stamped DON38.

D38E2: Mark is a “Lands and Surveys” pre cast SSM stamped DON38 Ecce 2.

DORIS GM (YARM): Domes 50107M005. Ground mark under the DORIS antenna. Mark consists of a punch mark in a brass pin set in concrete.

DORISP (YASM): Domes 50107M007. A Concrete Pillar, 0.6m diameter with a stainless steel plate set in the top. The mark refers to the intersection of the top of the stainless steel plate with the vertical axis of a 5/8" ϕ Whitworth threaded stainless steel spigot. The mark is also known as AU062.

DORISN (YASB): Domes 50107S011. The reference point on the DORIS Antenna (Type B) in service after the 27/11/03. The reference point consists of the intersection of the vertical central axis of the antenna with the red painted horizontal reference line. This point is vertically above DORISP.

AU063: Concrete pillar protruding 0.2m above ground level with a stainless steel plate set in the top. The mark refers to the intersection of the top of the stainless steel plate with the vertical axis of a 5/8" ϕ Whitworth threaded stainless steel spigot.

AU064: Concrete pillar protruding 0.2m above ground level with a stainless steel plate set in the top. The mark refers to the intersection of the top of the stainless steel plate with the vertical axis of a 5/8" ϕ Whitworth threaded stainless steel spigot.

GRAV: Brass domed plaque set in the concrete floor of the gravity hut within the Moblas 5 compound. Mark used for Absolute gravity observations. The reference point is the centre punch point in the middle of the plaque.

TBM5, TBM7: Screws driven into bitumen for temporary observation standpoints.



Calibration Pillars 2 and 3: Concrete pillars approximately 0.3m diameter. The mark refers to the intersection of the top of the stainless steel plate with the vertical axis of a 5/8" ϕ Whitworth threaded stainless steel spigot. The pillars are used to mount calibration reflectors for the SLR system and are also referred to as Moblas 5 pillar2, and 3.

3.1.2 Map of Network

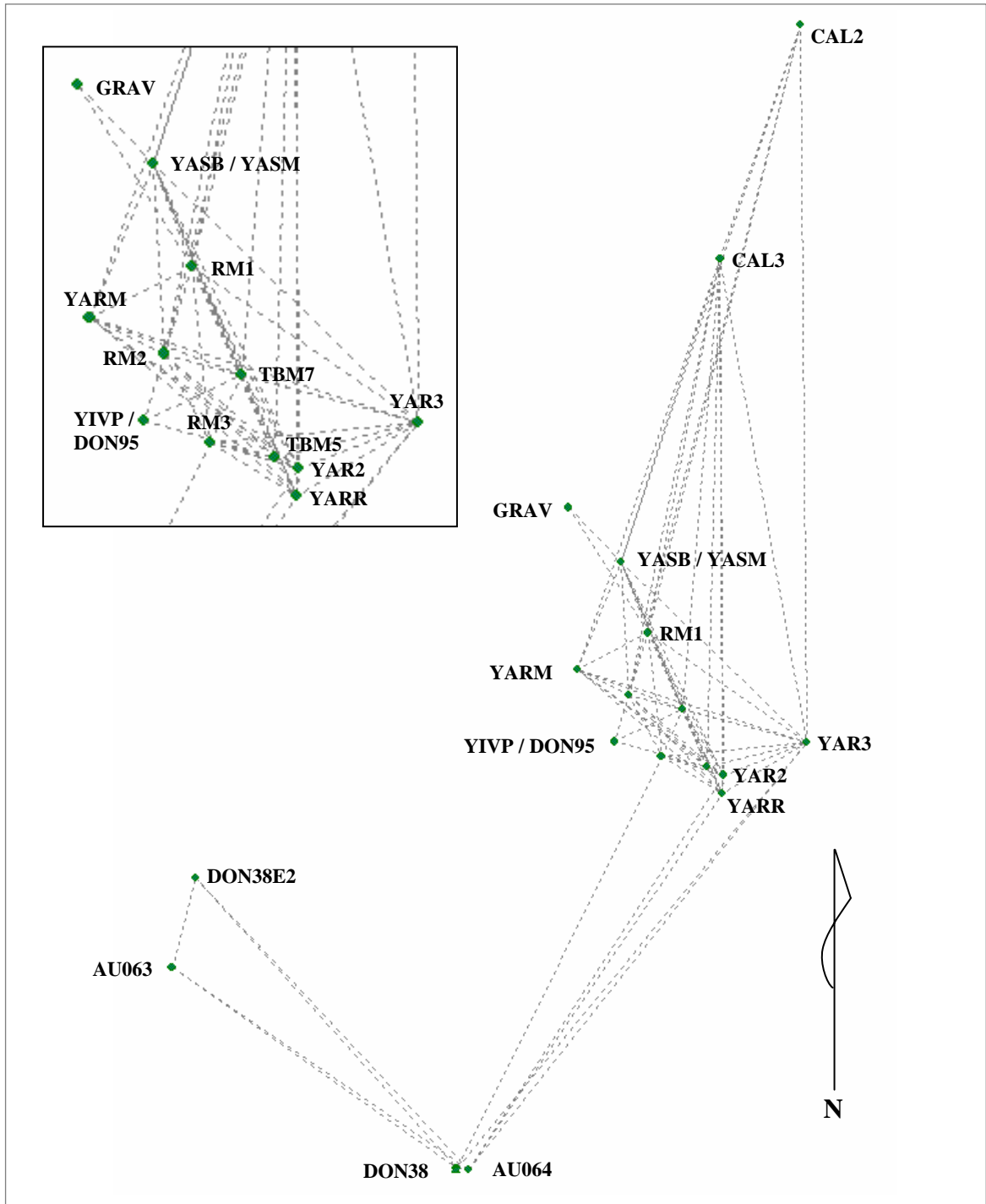

Figure 3: The Moblas 5 (Yarragadee) 2007 terrestrial geodetic network. Terrestrial observations between stations are shown as inter-connecting lines.

3.2 Representation of Reference Points

3.2.1 VLBI

No VLBI at the Moblas 5 (Yarragadee) SLR observatory. A new 12m diameter VLBI radio telescope is proposed to be co-located at the Yarragadee facility in the near future, as part of the AuScope geodetic infrastructure upgrade around Australia.

3.2.2 SLR

The Moblas 5 (Yarragadee) Satellite Laser Ranger (SLR) invariant reference point (IVP) is defined as the intersection of the azimuth axis with the common perpendicular of the azimuth and elevation axes (Johnston et al, 2004). In this survey, an indirect approach to invariant point, or system reference point, positioning was used to measure and thus derive the SLR IVP. This involved the derivation of the independent axes of rotation of the SLR through a process of three-dimensional circle fitting to the three dimensional coordinates of targets observed on the SLR telescope during rotational sequences. In the adjustment process, geometrical models describing target motion during rotation sequences were applied. The geometric models included inter-axis, inter-circle and inter-target conditions. These conditions are critical to the computation of unbiased IVP coordinates at the millimetre level for an SLR with rotational limits in elevation (Dawson et al, 2007).

Targets on the SLR were observed as it was rotated about one axis while the telescope was held fixed in the other axis. This follows that a target located on a rigid body, rotating about one independent axis can be used to express a circle in 3D space. A 3D circle can be described by seven parameters, namely:

- Circle centre (3 parameters)
- Unit normal vector (3 parameters) perpendicular to the circle plane
- Circle radius (1 parameter)

The method of IVP determination applied assumes that, during rotational sequences, targets follow a perfect circular arc in 3D space; that there is no deformation of the targeted structure during rotational sequences, and that the axis of interest can be rotated independently of the other axis. There are no assumptions of axis orthogonality, verticality, horizontality or the precise intersection of axes made using this IVP estimation technique.

The indirect geometrical models describing target motion during rotational sequences include several conditions:

- target paths scribe a perfect circle in 3D space during rotation about an independent axis;
- circle centres derived from targets rotated about the same axis are forced to lie along the same line in space;
- normal vectors to each circle plane derived from targets rotated about the same axis are forced to be parallel;
- orthogonality (or non-orthogonality) of the elevation axis to azimuth axis remains constant over all realisations of the elevation axis;
- identical targets rotated about a specific realisation of an axis will scribe 3D circles of equal radius;
- offset distance between the elevation axis and azimuth axis remains constant over all realisations of the elevation axis;



- distance between 3D circle centres for all realisations of the elevation axis are constant over all realisations of the elevation axis; and
- IVP coordinate estimates remain constant over all realisations (combinations) of the azimuth/elevation axis.

In addition, a constraint that the unit normal vector perpendicular to the plane of the circle must have magnitude one was required, as was a minimum of three rotational sequences to enable the solution of the equation of a circle. Multiple realizations of the elevation axis (i.e. observed at multiple azimuths) were observed and computed. A least squares method was used for the computation of the axes of rotation and the IVP

The linearized equations take the form of two sets of equations, namely conditions and constraints with added parameters

$$Av + B\Delta = f$$

$$D_1\Delta + D_2\Delta' = h$$

where v is the parameter vector of residuals of the input classical adjustment results, Δ is the parameter vector of the circle parameters, Δ' is the parameter vector of the parameters associated with the IVP estimates, f and h are the constant vectors associated with the evaluation of the conditions and constraints respectively and A , B , D_1 and D_2 are matrixes of coefficients. The least squares solution is obtained from the following system of normal equations

$$\begin{bmatrix} -W & A^t & 0 & 0 & 0 \\ A & 0 & B & 0 & 0 \\ 0 & B^t & 0 & D_1^t & 0 \\ 0 & 0 & D_1 & 0 & D_2 \\ 0 & 0 & 0 & D_2^t & 0 \end{bmatrix} \begin{bmatrix} v \\ k \\ \Delta \\ k_c \\ \Delta' \end{bmatrix} = \begin{bmatrix} 0 \\ f \\ 0 \\ h \\ 0 \end{bmatrix}$$

where W is the weight matrix of the input coordinates derived from the classical adjustment and k and k_c are vectors of Lagrange multipliers required to satisfy the Least Squares criteria.



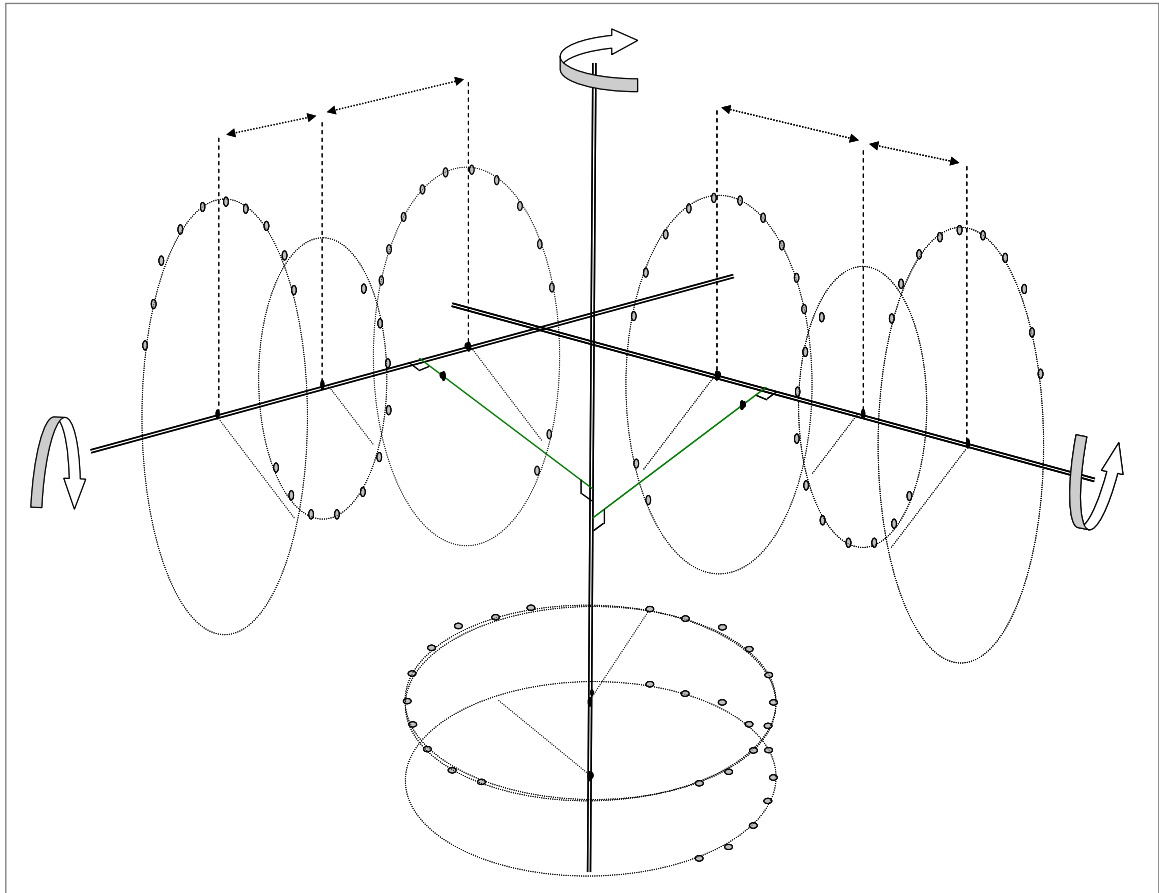

Figure 4: IVP model. Circle centres derived from targets observed while being rotated about the same axis are forced to lie along the same line in space. Normal vectors to the circle plane derived from targets observed while being rotated about the same axis are forced to be parallel. Note that to simplify the diagram only two targets are shown on the azimuth axis and three targets are shown on the elevation axis. The two realisations of the elevation axis allow for the constraint of the circle radius parameters, as can the inter-circle centre distances. The angle between the elevation and azimuth axis (i.e. axis orthogonality) should be constant over all realisations of the elevation axis. The IVP estimate should be constant over all realisations of elevation/azimuth axis combinations.

The solution to the normal equation system is iterated as required for the non-linear condition and constraint equations. An updated estimate of the input coordinates and their variance-covariance matrix is obtained together with an estimate of the IVP coordinate, their variance-covariance matrix and the inter-relating covariance matrix.

Results from the 2001 survey are detailed in Johnston *et al* (2001). Results from the 2003 survey are detailed in Johnston and Dawson (2004).

In order to generate the circles required for IVP determination, measurements were made to a number of targets placed on the SLR as the telescope was rotated through several orientations. In particular, the targets on the SLR were observed from two stand points as the SLR was rotated in azimuth (with the elevation set at approximately 177 degrees). The targets on the SLR were observed from the same two stand points as the telescope was rotated in elevation (with the azimuth set orthogonal to the line of sight of the total station for each set of observation sessions).

Table 2: 2007 Moblas 5 (Yarragadee) local tie survey IVP determination observations

Axis	Number of targets	Description / Comment
Azimuth	3	Elevation axis fixed at 177°, near horizontal Azimuth axis rotated in 20° increments through the full 360° Telescope observed from two standpoints, namely YAR3 and RM1 3 x Leica Precision Prisms
Elevation	6	Azimuth axis set orthogonal to line of sight Elevation axis rotated in ~10° increments through 180° Telescope observed from two standpoint, namely YAR3 and RM1 6 x Leica Precision Tape Targets

3.2.3 GPS

In the case of Yarragadee, the GPS antennae were removed during the survey and the monuments were observed directly.

3.2.4 DORIS

The position of the DORIS antenna was determined indirectly by observation to the sides of the antenna at the physical red marker line. Observations were reduced by averaging and then intersected in the geodetic adjustment in the conventional manner.

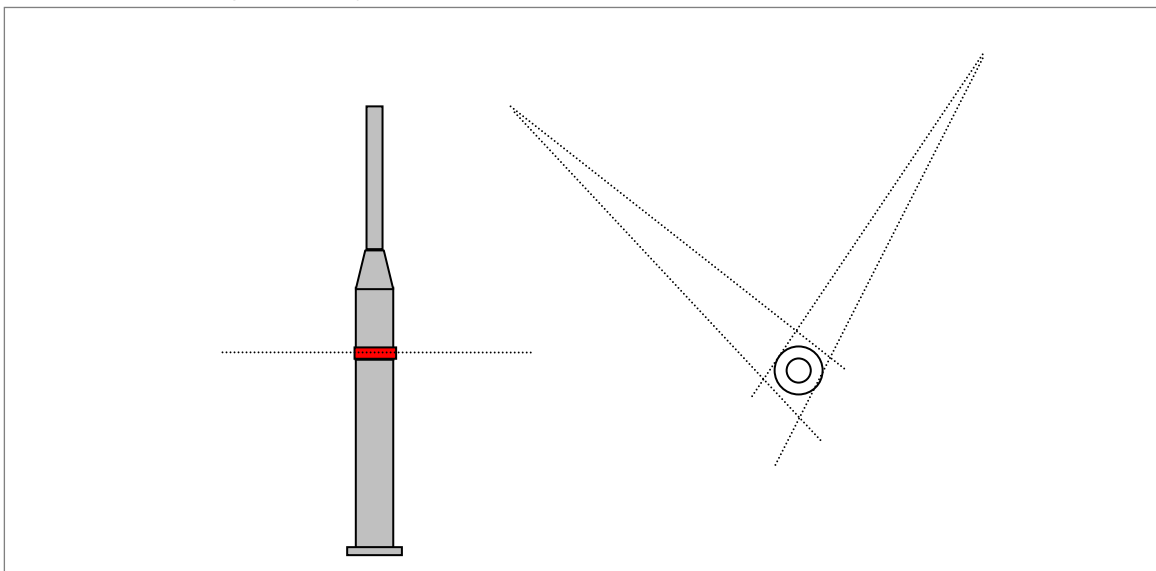

Figure 5: Horizontal view (left) and plan view (right) of a DORIS antenna reference point (centre of antenna at red mark line).



3.2.5 GLONASS

In the case of Yarragadee, the GLONASS antennae were removed during the survey and the monuments were observed directly.

4. Observations

4.1 Conventional Survey

4.1.1 Network Survey

A terrestrial network survey was conducted between the permanent survey monuments within and around the SLR observatory. Leica Precision-Prisms were measured using the Leica TCA2003 total station, which recorded horizontal and vertical directions as well as slope distances. Four rounds of face left, face right observations were taken from each standpoint to all surrounding, visible survey marks. Approximate target heights and instrument heights were measured with a steel ruler or measuring tape for each set of observations. The instrument and target heights were later refined using the observed observations and precise knowledge of the height of survey marks. For each instrument setup, meteorological information (temperature, pressure, humidity) was recorded and was applied, as well as prism offset corrections, to observations as part of data pre-processing. The survey marks included in the survey are listed in Table 3.

Table 3: Survey marks included in the 2007 Moblas 5 Yarragadee local tie survey

Ground Marks	Pillars	Observed Marks	Observed Systems
YARR (AU053)	YAR3	DON95	DORIS (YASB)
DON95 RM1	CAL2	DON38	YIVP
DON95 RM2	CAL3	DON38 Ec	MET
DON95 RM3	AU063	DORIS P (YASM)	
YAR2 (RM4)	AU064	GRAV	
DORIS GM (YARM)		GRAV2	
TBM5			
TBM7			

4.2 Levelling

High precision levelling was conducted between the survey pillars and Reuger heighting pins, using the EDM-height traversing technique (Johnston et al, 2002). Height difference observations were made using a Leica TCA2003 Total Station sighting to a Leica precision prism mounted on a fixed height prism pole (approximately 1.5m in length), or mounting stub (approximately 0.2m in length). The prism pole was used to observe ground marks while the mounting stub was used to observe pillar monuments. The offset in height between the 1.5m pole and the 0.2m stub was determined prior to the survey and applied to level observations made between the two separate mounts.

Levelling loops covering all monuments in the survey network were completed in both directions. Each instrument setup involved recording four rounds of face left, face right observations, to the prism set up over two survey marks. A 50m tape was used to measure between the survey marks so that the total station could be set up approximately half way between points. Temperature, pressure and humidity readings were entered into the total station



prior to observing so that the instrument derived parts per million (ppm) values could be applied to measurements. Level run sets were processed through in-house least squares adjustment software, to derive adjusted height differences between all survey marks.

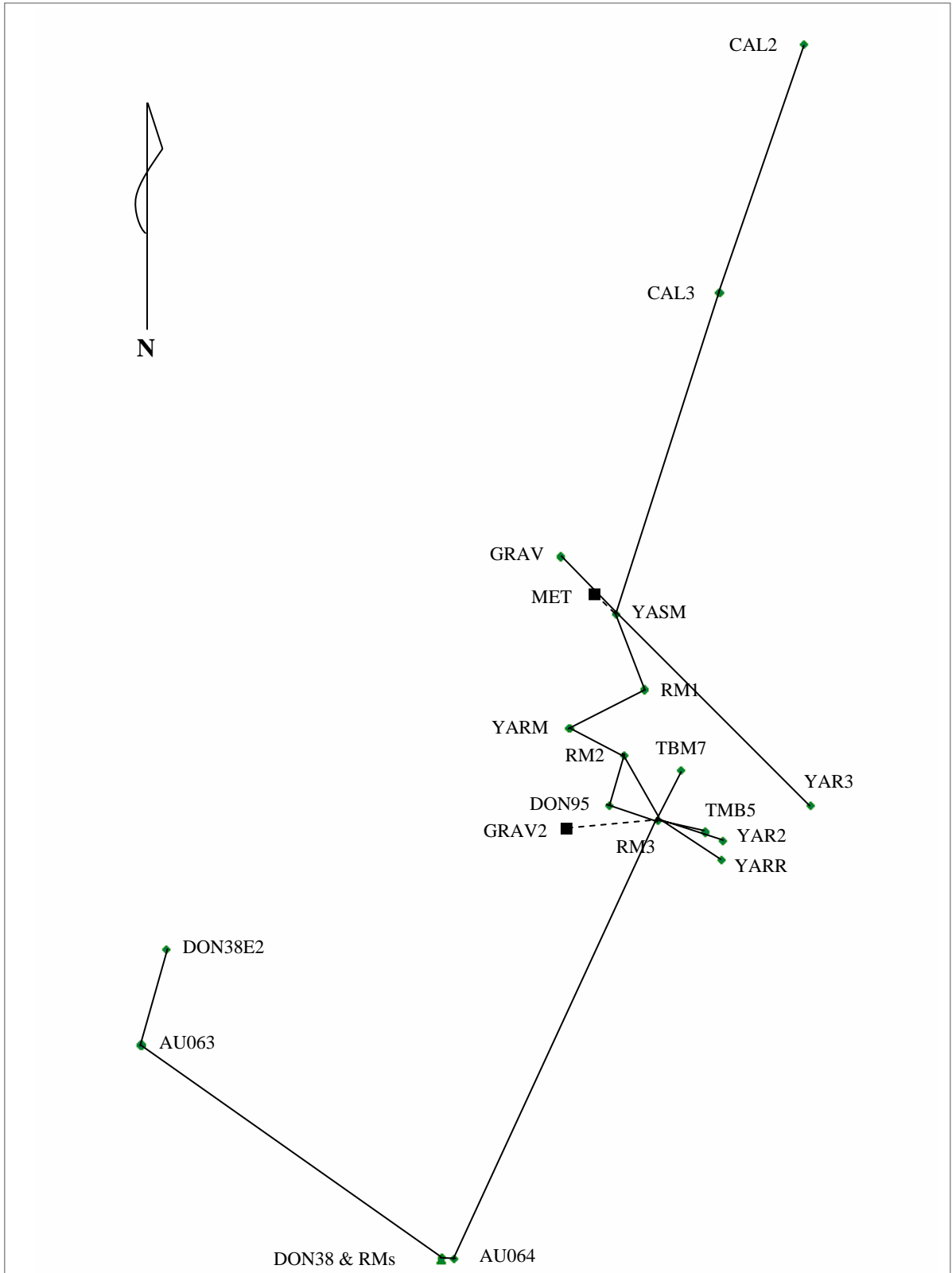

Figure 6: Yarragadee survey levelling observations.

As part of the levelling survey, connections were made to the three reference marks surrounding DON38. Additional observations were made to the base of the Met station located alongside the DORIS pillar and to an extra gravity bench mark identified next to the SLR support structure. An approximate height for the Met station pressure sensor was obtained using a tape measure to determine the offset from the concrete support to the base of the barometer.

Relative changes in height from RM1:

- GRAV2 (additional gravity benchmark): 0.3227m
- Met station pressure sensor: 0.8283m (-0.2077m + 1.036m)

4.3 SLR

4.3.1 Azimuth Observations

Observations were taken from two separate instrument stations (YAR3, DON95 RM1) to three Leica Precision Prisms as the telescope was rotated in azimuth (with the telescope elevation set at near horizontal – 177 degrees). Prisms were attached to the SLR structure using tribrachs screwed directly onto the structure (trunnion axis) and on a modified tribrach which rested on top of the telescope. Figure 7 shows the positioning of targets on the telescope structure. The telescope was rotated through the full 360 degrees at 20 degree increments. All visible targets were measured with each orientation. Not all targets could be observed at each orientation as targets were often obstructed by the telescope structure or each other.

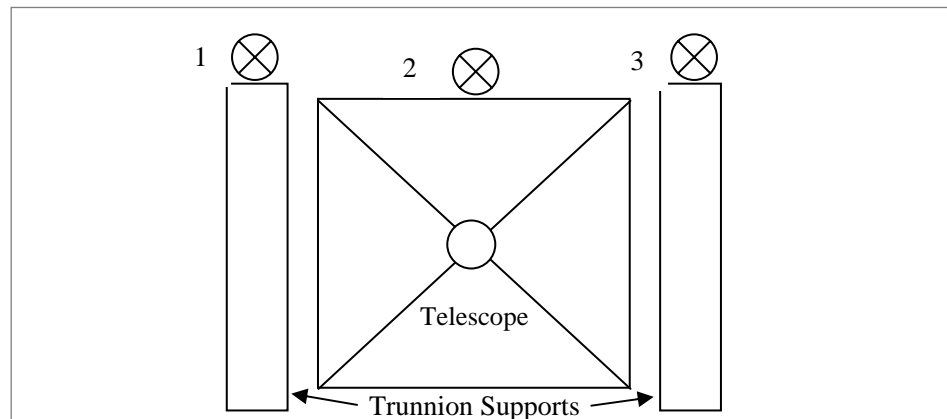

Figure 7: SLR Azimuth rotation - survey target positions on telescope structure

The standard measurement procedure involved setting up over one of the survey marks. Atmospheric information (temperature, pressure, humidity) was recorded at the start of each instrument setup and was later applied to the observations in post processing using software developed at Geoscience Australia. Target heights were measured at each prism, using a ruler or tape, as a rough initial guide to target height. These heights were updated later in post processing.

The Reuger heighting technique (Reuger & Brunner, 1981) was applied, at the beginning and end of each observation session, using survey pins located in close proximity to the instrument setup point. This measurement technique involved the observation of one round of FL/FR vertical angles to specific graduations on a levelling staff (0.8m, 1.2m, 1.6m, 2.0m) placed on a levelled survey mark (Figure 8). This technique works best when the mid graduation of the levelling staff are approximately horizontal to the instrument trunnion axis (90 degrees). Height differences computed as part of the levelling survey (refer to section 4.2) were utilised to determine the precise height of instrument.



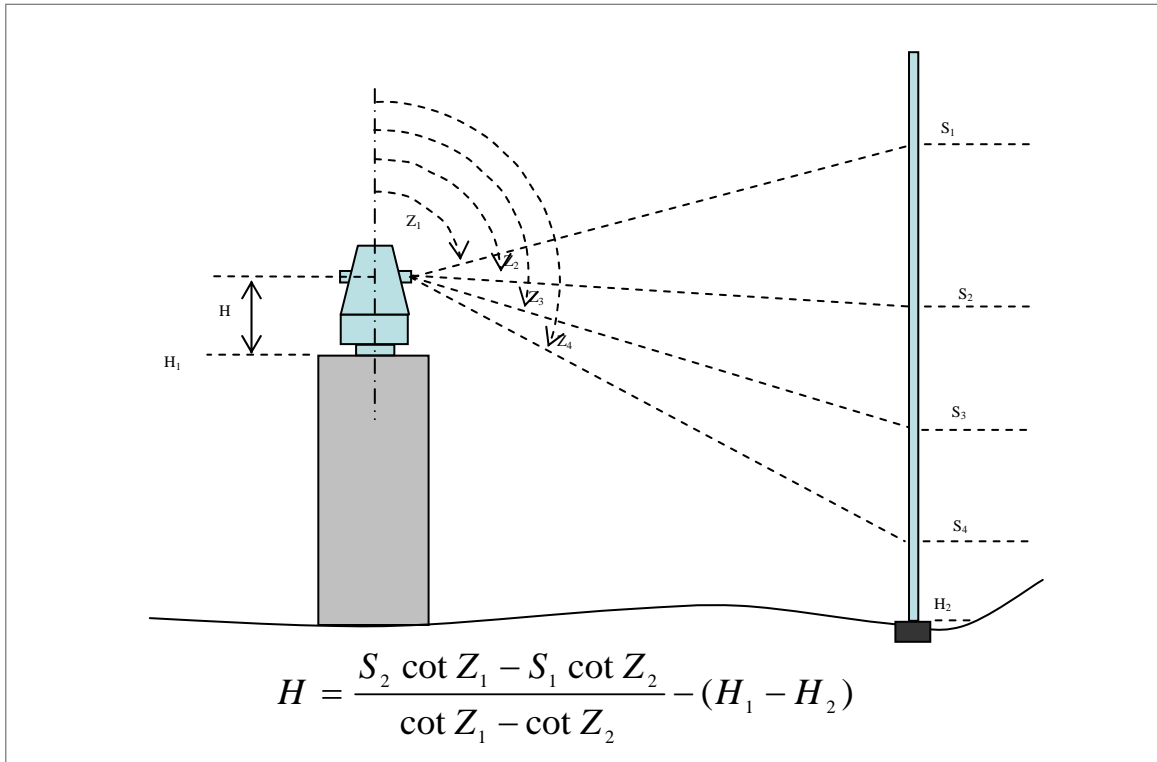

Figure 8: Total station instrument heighting technique, where S_n are staff readings; Z_n are zenith angles (Rueger & Brunner, 1981).

A *Leica* precision prism was placed on a distant survey pillar (CAL3), selected as the back sight for the SLR target survey, and a single set of dual face pointings were made to the back sight and as many of the three targets placed on the SLR as visible. Observations were taken to the targets on the SLR when it was positioned at 177 degrees elevation and zero azimuth. Observation sets were taken to the SLR targets as the SLR was re-orientated in azimuth at separate 20 degree increments until it had completed a full 360 degree rotation.

4.3.2 Elevation Observations

A similar procedure to that described above was followed for observations to the targets positioned on the SLR as it was rotated through elevation settings. Observations were taken from two instrument set up locations (YAR3, DON95 RM1) to six *Leica* tape targets placed on the SLR (as shown in Figure 9) as the telescope was rotated in elevation, with the telescope azimuth set on a bearing orthogonal to the total station line of sight. This direction was approximated in the field (Bearing of 0 and 288 degrees for observations from YAR3 and RM1, respectively). The telescope was rotated through 180 degrees at 10 degree increments. The SLR was rotated by the computer system, controlled remotely by a telescope operator.

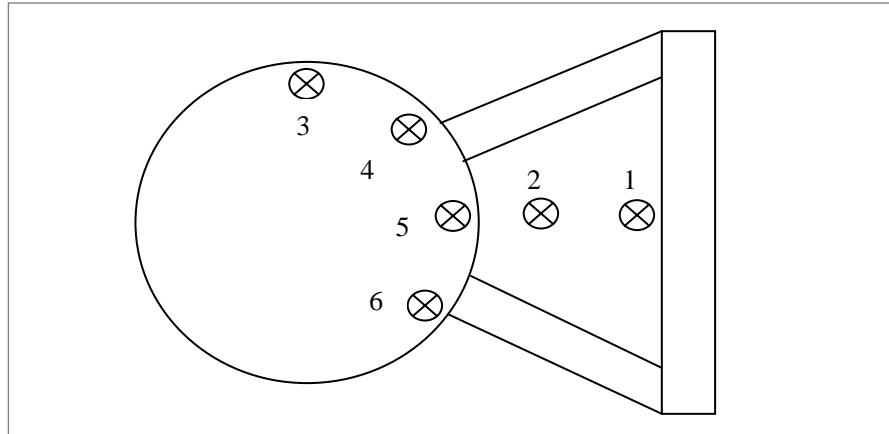

Figure 9: Elevation rotation - survey target positions on telescope structure

Reuger heighting observations were taken to two nearby ground marks at the beginning and end of the survey. These measurements were used to derive the instrument height accurately, which was important for the observation of target elevations. In conducting the survey, a distant survey pillar was selected as the back sight and single sets of dual face pointing were made to the back sight and the six targets placed on the SLR. Observations were taken to the targets at 10 degree increments of the SLR as it was rotated through elevation settings.

4.4 DORIS and MET Station

Observations were taken to the DORIS station from two survey pillars (DON95 RM1, DORIS GM). These two observation stations provided a strong geometry as they are approximately perpendicular to each other with respect to the DORIS station. Four rounds of face left, face right observations were taken to Leica retro-reflective targets placed on the DORIS at the reference point. Two targets were also placed on the DORIS, in line with each of the survey pillars. Additional observations were taken to the left and right sides of the DORIS, along the bottom of the reference line, to support improved centre point positioning of the beacon. These observations were merged in with the terrestrial network observation sets. The level at the base of the Met station was precisely determined as part of the levelling survey.

4.5 GPS

```
+SOLUTION/EPOCHS
*CODE PT SOLN T _DATA_START_ _DATA_END_ _MEAN_EPOCH_
YAR2 A 1 P 07:150:03600 07:150:86400 07:150:44985
AU63 A 1 P 07:150:03600 07:150:86400 07:150:44985
AU64 A 1 P 07:150:03600 07:150:86400 07:150:44985
-SOLUTION/EPOCHS
```

4.6 General Comments

None.

5. Data Analysis and Results

The flow chart of the analysis process used for the Yarragadee survey is detailed in Figure 10. Coordinate solutions are generated in three steps: first at the completion of the classical geodetic adjustment (*Step A*); second at the completion of the geometrical modelling where the impact of the geometrical model is propagated throughout the input classical adjustment results (*Step B*); and third after transformation (*rotation and translation*) of the ‘geometrically modified’ solution onto the required global reference frame (*Step C*).

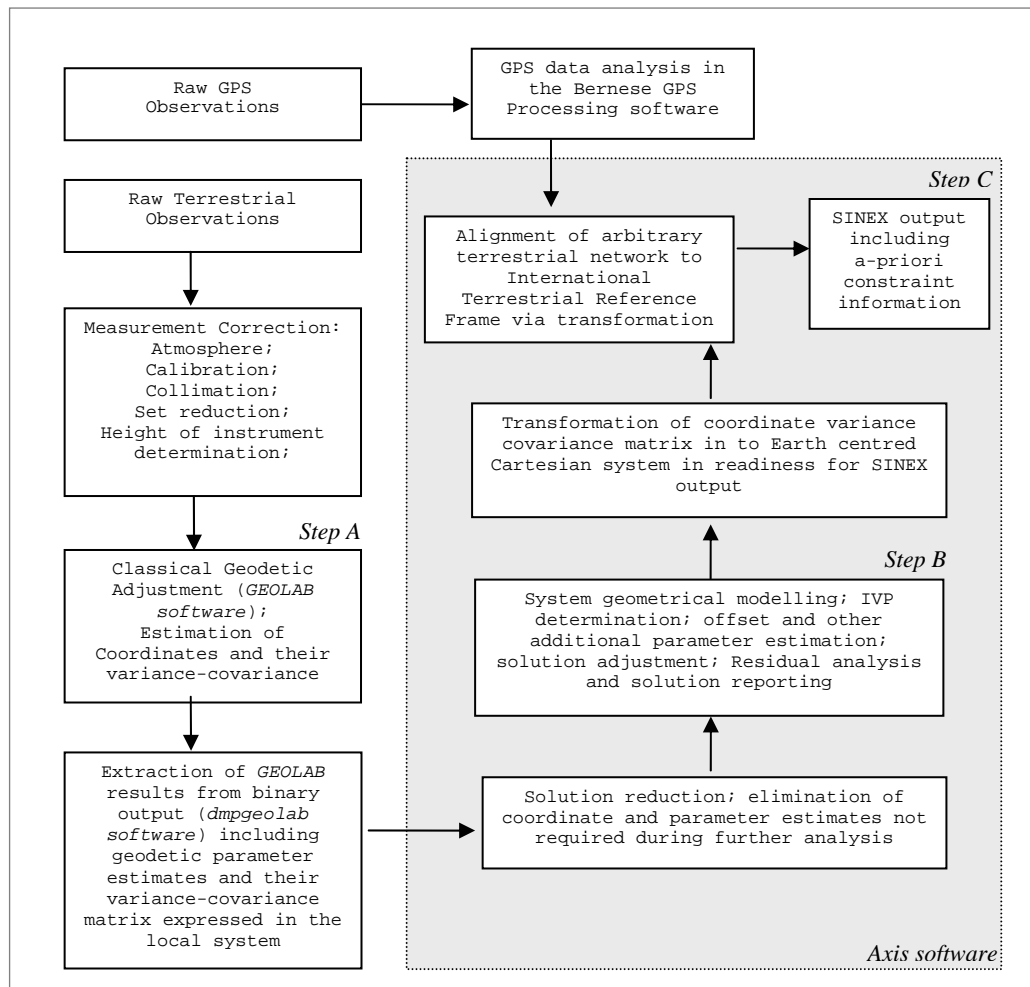

Figure 10: Analysis process for the reduction of local survey data.



5.1 Data Pre-processing

5.1.1 Levelling

Levelling GSI files were edited and passed through Geoscience Australia's levelling1.exe software to derive changes in height between survey marks. Levelling misclosures were noted as being well within zero order levelling requirements. Levels were determined for survey marks with DON95 RM1 fixed in height as a known point from the previous local tie survey. Orthometric height differences were noted between survey marks for use in the adjustment.

5.1.2 Reuger heighting

Reuger heighting observations recorded during the SLR survey to the survey pins close by instrument stations were extracted from the FLD files and entered into an excel spreadsheet set up to derive instrument heights from vertical angles read to a levelling staff. The mean height of instrument value was computed from a number of observation sets.

5.1.3 Network survey

GSI files were reformatted into FLD files using in house software developed by Geoscience Australia, *GSI2FLD*. Meteorological data and prism correction data were entered into the FLD files. These files were then run through Angles.exe to generate IOB files. The vertical angles and slope distance values were then entered, with heights of instrument computed through the Reuger heighting technique, into a spreadsheet set up to derive heights of targets using these observations. The height of target and height of instrument values were entered into the IOB files for the relevant observation sets. Orthometric height difference values derived through the levelling data processing were added to the IOB file. Measurement precision estimates were also added to the IOB file for each observation type. The precision values entered included:

Slope distance: $0.001\text{m} + 1\text{ppm}$
Horizontal direction: 1 and 2 second
Zenith angle: 1 second
Orthometric height difference: 0.0002m

It should be noted that a horizontal direction precision of 2 seconds was applied for observations between the survey marks in the terrestrial network survey. This ensured the best fit for the adjustment and is probably due to the imprecision brought about through repeated tripod setups.

5.1.4 DORIS observations

The horizontal direction to the centre of the DORIS beacon was computed as the average of the observations taken to the left and right of the DORIS beacon along the base of the reference line. The direction measurements were updated in the IOB file. The zenith angle and slope distance observations were adjusted to account for the DORIS beacon radius of 0.027m and the requirement of determining the intersection of the vertical axis of the DORIS antenna with the plane coinciding with the base of the reference height line. The adjusted observations were entered into the IOB file.

5.2 Classical Geodetic Adjustment

Classical geodetic adjustment was undertaken using *GeoLab* version 2.4d geodetic adjustment software. Prior to this, three dimensional coordinates for the fundamental pillar (YAR2) and the



CAL3 were constrained in the IOB files as the primary constraint on the network, as was done in the previous local tie survey adjustment. Due to confidence in the height difference observations, derived from the precise total station levelling, the zenith angle measurements between survey marks were commented out of the IOB file. This placed all emphasis on the levelled, orthometric height differences in determining survey monument heights. The IOB file was run through the *GeoLab* version 2.4d geodetic adjustment software until coordinates converged, with derived coordinates repeatedly being added to the IOB file as initial coordinate estimates in the adjustment process. Once convergence was reached, the primary constraint on the network was loosened up to act as a minimum constraint with YAR2 held fixed in latitude, longitude and height and CAL3 only held fixed in longitude, allowing for movement in the north-south directions and also in height. The final adjustment was run. It should be noted that corrections for the geoid and deflection of the vertical were not applied as part of the classical geodetic adjustment.

5.2.1 Topocentric coordinates and covariances

Geodetic coordinates (GRS80 Ellipsoid) provided in the arbitrary local terrestrial system before alignment to the ITRF2000 are given below:

Table 4: Yarragadee terrestrial survey results. GRS80 ellipsoid. Heights are ellipsoidal, arbitrary local frame.

STATION			LATITUDE			LONGITUDE	HEIGHT (M)
RM1	S	29	02	46.66195	E	115 20 48.54397	241.0240
RM2	S	29	02	47.07034	E	115 20 48.40321	241.1932
RM3	S	29	02	47.47542	E	115 20 48.64968	241.3347
YAR2	S	29	02	47.59937	E	115 20 49.11507	241.2842
YAR3	S	29	02	47.38646	E	115 20 49.74310	242.4393
YARR	S	29	02	47.72515	E	115 20 49.10441	241.3612
AU63	S	29	02	48.87032	E	115 20 44.95936	241.2528
AU64	S	29	02	50.19983	E	115 20 47.18687	242.6741
CAL2	S	29	02	42.65513	E	115 20 49.69348	241.1695
CAL3	S	29	02	44.19749	E	115 20 49.08885	242.0233
D381	S	29	02	50.19019	E	115 20 47.09523	242.6825
D382	S	29	02	50.19019	E	115 20 47.09524	242.5659
D383	S	29	02	50.19019	E	115 20 47.09523	242.5122
D38E	S	29	02	48.27891	E	115 20 45.14055	241.2856
DN38	S	29	02	50.18298	E	115 20 47.10114	242.7972
DN95	S	29	02	47.38142	E	115 20 48.29603	241.3273
GRAV	S	29	02	45.83037	E	115 20 47.94588	240.7486
TBM5	S	29	02	47.54675	E	115 20 48.98694	241.2718
TBM7	S	29	02	47.16902	E	115 20 48.81080	241.1700
YARM	S	29	02	46.90540	E	115 20 48.01779	241.1594
YASB	S	29	02	46.19189	E	115 20 48.34779	243.0394
YASM	S	29	02	46.19191	E	115 20 48.34784	242.3079

5.2.2 Correlation matrix

The computed correlation matrix was too large to be included in this report, please refer to the SINEX file (see section 5.5) for further information of this type.

5.2.3 Reference temperature

No thermal corrections have been applied for structural expansion of the SLR instrument. Since the structure is small, thermal deformation is ignored.

5.3 IVP Determination

At this stage three dimensional coordinates had been computed for each target at each orientation of the SLR. These points were used to derive three dimensional circles in space, which were used to determine the SLR IVP.

The .par, .con and .inv propriety binary *GeoLab* format files generated from the *GeoLab* adjustment were run through the Geoscience Australia developed *dmpgeolab* software to extract the solution data, including a full variance-covariance matrix, and create an ASCII format .vcv file required for the IVP determination software *axis*, developed by Geoscience Australia. The .vcv file was placed into a directory with the *axis* software along with a setup.axs file. The setup file was edited repeatedly to derive estimates of circle parameters for each target and each rotation sequence. Once initial estimates were refined for all target rotation sequences, geometric constraints were added. Initial constraints introduced included:

- ENORMAL, NNORMAL, UNORMAL – used to constrain normal parameters together;
- TOUCH – used to force two axes to touch each other (in 3D) at some reference point;
- RADIUS – used to constrain circle arc radius parameters together;
- CENTRE – used to constrain together centre to centre distances;
- DELETE – used to omit unwanted target positions from the adjustment procedure.

With updated circle parameter estimates for each target rotation sequence, IVP coordinates were derived. Additional constraints were introduced to constrain separate IVP realisations. Constraints applied included:

- OFFSET – used to constrain the computed offset to be identical for independent IVP estimates;
- ORTHOG – used to constrain the orthogonality between three axes;
- UIVP – used to constrain the individual IVP determination in the up component together.

5.4 Transformation

This procedure produced the final IVP coordinate estimates. The *axis* software was used to transform (through translation and rotation only) the terrestrial network and computed IVP coordinate with the variance-covariance matrix from a local to a global reference frame. Coordinates derived from the previous local tie survey were used to align the survey to the global reference frame for comparison of surveys. Coordinates derived from the processing of the GPS data collected on site were used to align the network solution to ITRF2005. Three alignment stations with XYZ earth-centred Cartesian coordinates were specified as stations for the local to global transformation.

5.5 SINEX File Generation

A SINEX format solution file was created using the *axis* software. The SINEX naming convention adopted by Geoscience Australia for local survey data is:

XXXNNNNYYMMFV.SNX

where

- XXX** is a three character organisation designation;
- NNNN** is a four character site designation;
- YY** is the year of survey;
- MM** is the month of survey;



F is the frame code (G for global frame; L for local frame); and
V is the file version.

The SINEX file corresponding to this report is *AUSYARR0705GA.SNX*, and can be found at <ftp://ftp.ga.gov.au/sgac/sinex/ties/>. This file supersedes the SINEX file *AUSYARR0311GA.SNX* submitted to the International Earth Rotation Service (IERS).

5.6 GPS

GPS data analysis was undertaken using the Bernese GPS processing software version 5.0. International Terrestrial Reference Frame 2005 (ITRF2005) coordinates of the permanent GPS station, YAR2 (50107M004) were adopted for the observation session. Both L1 and L2 observations were used and no troposphere models were estimated. The observations were processed to a 10° cut-off. Carrier phase ambiguities were resolved to their integer values. The final International GPS Service (IGS) orbits and Earth orientation parameters were used in the processing. IGS recommended constant and elevation dependent antenna phase models were also applied.

Table 5: Yarragadee 2007 GPS survey results. GRS80 ellipsoid. Heights are ellipsoidal. Aligned to ITRF2005 at 30 May 2007.

Station	Latitude	Longitude	Height (m)
YAR2 50107M004	S 29 02 47.59242	E 115 20 49.11990	241.2932
AU063	S 29 02 48.86339	E 115 20 44.96415	241.2848
AU064	S 29 02 50.19293	E 115 20 47.19167	242.7059

5.7 Additional Parameters

Additional system parameters were computed during the IVP estimation process.

For the telescope IVP (*YIVP 50107S007*) the azimuth axis deflection from the vertical was estimated as 1' 55.2" at an azimuth of 83° 42' 18.8". The orthogonality (or non-orthogonality) of the azimuth to the elevation axes was estimated to be 90° 0' 43.0". The offset distance between the azimuth and elevation axis was estimated to be 0.5 mm.

Table 6: Yarragadee, final results, topocentric vectors between SLR IVP (*YIVP 50107S007*) and permanently mounted calibration pillar reflectors

STATION	EAST (M)	NORTH (M)	UP (M)	RANGE (M)
2007				
CALT2	37.7987	145.5590	-3.3076	150.4231
CALT3	21.4380	98.0669	-2.4440	100.4125

Table 7: Yarragadee, Horizontal and height offsets of calibration retro-reflector targets from pillar reference points, azimuth from pillar reference point to SLR IVP, differences in XYZ from pillar reference point to retro-reflector point.

Reflector	Offset	Height	Azimuth			ΔX	ΔY	ΔZ
CALT2	0.0357	0.0675	14	33	25.4814	-0.0406	0.0647	-0.0026
CALT3	0.0310	0.0649	12	19	52.0258	-0.0366	0.0617	-0.0050



Table 8: Yarragadee, final results, topocentric vectors between SLR IVP (YIVP 50107S007) and observed points in Yarragadee network.

Station	East (m)	North (m)	Up (m)	Range (m)
YAR2	22.1403	-6.7045	-3.2274	23.3572
YARR	21.8519	-10.5770	-3.1494	24.4805
DN95	-0.0190	0.0062	-3.1823	3.1824
YASB	1.3817	36.6309	-1.4776	36.6867
YASM	1.3830	36.6303	-2.2089	36.7229
YARM	-7.5469	14.6623	-3.3520	16.8278
YAR3	39.1322	-0.1490	-2.0752	39.1875
RM1	6.6891	22.1582	-3.4908	23.4076
RM2	2.8807	9.5838	-3.3187	10.5433
RM3	9.5490	-2.8881	-3.1758	10.4695
AU63	-90.2931	-45.8362	-3.2365	101.3128
AU64	-30.0274	-86.7699	-1.8153	91.8366
CAL2	37.7898	145.5243	-3.3751	150.3888
CAL3	21.4312	98.0365	-2.5089	100.3830
DN38	-32.3466	-86.2513	-1.6920	92.1328
GRAV	-9.4925	47.7617	-3.7691	48.8415
TBM5	18.6737	-5.0845	-3.2394	19.6228
TBM7	13.9082	6.5457	-3.3429	15.7308

5.8 Discussion of Results

Table 9: Yarragadee, final results, cartesian XYZ coordinates (metres), ITRF2005 at 30 May 2007 and final precision estimates (1σ , millimetres)

Station	X (m)	σ	Y (m)	σ	Z (m)	σ
YAR2	-2389026.0253	0.3	5043316.9597	0.1	-3078530.2045	0.1
YARR	-2389024.9889	0.3	5043315.4456	0.2	-3078533.6278	0.2
DN95	-2389007.4108	0.5	5043329.4261	0.3	-3078524.3597	0.3
YASB	-2389016.9271	0.5	5043346.2435	0.4	-3078493.1691	0.5
YASM	-2389016.6544	0.5	5043345.6649	0.4	-3078492.8146	0.4
YARM	-2389003.5903	0.4	5043338.9455	0.3	-3078511.4646	0.4
YIVP	-2389008.6177	0.4	5043331.9295	0.4	-3078525.9102	0.3
YAR3	-2389043.1752	0.3	5043313.4723	0.3	-3078525.0329	0.2
RM1	-2389017.9620	0.4	5043336.0305	0.3	-3078504.8441	0.3
RM2	-2389011.9710	0.4	5043332.2795	0.3	-3078515.9205	0.3
RM3	-2389015.4586	0.3	5043324.0653	0.2	-3078526.8931	0.2
AU63	-2388916.2785	0.3	5043347.9145	0.2	-3078564.4100	0.2
AU64	-2388962.7666	0.2	5043305.2770	0.1	-3078600.8853	0.2
CAL2	-2389071.7535	1.2	5043376.9384	0.9	-3078397.0504	0.5
CAL3	-2389047.4236	0.9	5043363.7892	0.6	-3078438.9860	0.3
DN38	-2388960.8245	0.6	5043306.5948	0.4	-3078600.4918	0.5
GRAV	-2389008.5556	0.7	5043353.9722	0.7	-3078482.3257	0.8
TBM5	-2389023.2246	0.3	5043319.1450	0.3	-3078528.7824	0.2
TBM7	-2389021.2964	0.3	5043326.2065	0.3	-3078518.5647	0.2

Table 10: Yarragadee, final results, geographic coordinate, ITRF2005 at 30 May 2007.

Station	Latitude			Longitude			Height
YAR2	-29	02	47.59245	115	20	49.11987	241.2932
YARR	-29	02	47.71823	115	20	49.10921	241.3712
DN95	-29	02	47.37449	115	20	48.30083	241.3382
YASB	-29	02	46.18496	115	20	48.35261	243.0431
YASM	-29	02	46.18498	115	20	48.35265	242.3118
YARM	-29	02	46.89848	115	20	48.02259	241.1686
YIVP	-29	02	47.37469	115	20	48.30154	244.5206
YAR3	-29	02	47.37953	115	20	49.74792	242.4455
RM1	-29	02	46.65502	115	20	48.54878	241.0298
RM2	-29	02	47.06342	115	20	48.40801	241.2019
RM3	-29	02	47.46850	115	20	48.65448	241.3448
AU63	-29	02	48.86340	115	20	44.96416	241.2848
AU64	-29	02	50.19289	115	20	47.19168	242.7059
CAL2	-29	02	42.64820	115	20	49.69828	241.1472
CAL3	-29	02	44.19056	115	20	49.09366	242.0125
DN38	-29	02	50.17605	115	20	47.10595	242.8292
GRAV	-29	02	45.82344	115	20	47.95068	240.7516
TBM5	-29	02	47.53983	115	20	48.99174	241.2811
TBM7	-29	02	47.16210	115	20	48.81560	241.1777

Table 11: Yarragadee, final results, cartesian difference vectors (metres). Comparison of 2003 and 2007 results. All aligned to ITRF2000 at date of 2003 survey.

From	To	ΔX (m)	ΔY (m)	ΔZ (m)	Range
2007					
YIVP	YAR2	-17.4086	-14.9686	-4.2943	23.3572
YIVP	YARR	-16.3717	-16.4836	-7.7172	24.4805
YIVP	DN95	1.2064	-2.5032	1.5512	3.1824
YIVP	YASB	-8.3136	14.3218	32.7366	36.6867
YIVP	YASM	-8.0410	13.7432	33.0912	36.7228
YIVP	YARM	5.0257	7.0184	14.4450	16.8278
YIVP	YAR3	-34.5598	-18.4529	0.8749	39.1874
2003					
YIVP	YAR2	-17.4091	-14.9676	-4.2929	23.3567
YIVP	YARR	-16.3729	-16.4839	-7.7170	24.4815
YIVP	DN95	1.2058	-2.5026	1.5522	3.1822
YIVP	YASB	-8.3161	14.3223	32.7355	36.6865
YIVP	YASM	-8.0418	13.7432	33.0914	36.7231
YIVP	YARM	5.0239	7.0185	14.4458	16.8280

The least squares solution of the SLR IVP position included: 18 targets; 2 IVP estimates (constrained together); 867 pseudo-observations; 157 unknowns; 560 conditions; 34 constraints and 104 additional constraints. The resultant linear system was 1622 x 1622 with degrees of freedom 1408. The computed variance factor was 0.2198. IVP model (circle) fit residuals were 0.4 mm Root Mean Square Error (RMS) for the in-plane residuals and 0.4 mm for the out-of-plane residuals.

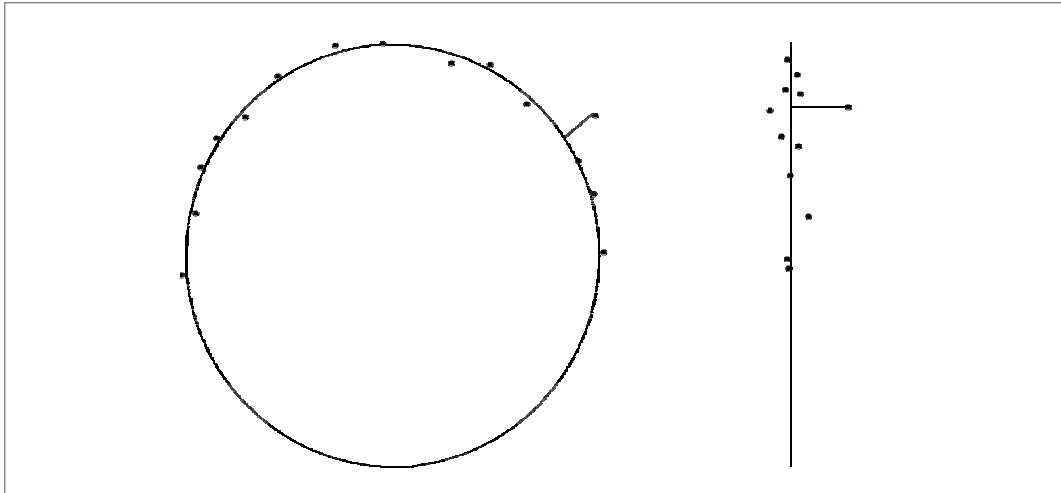

Figure 11: Circle fitting residuals; left in-plane residuals; right out-of-plane residuals.

5.9 Comparison with Previous Surveys

In general there is good agreement between the 2003 and 2007 surveys. This indicates reasonable network stability at the site between these epoch surveys.

Table 12: XYZ Residuals between the 2003 and 2007 surveys. Both surveys aligned to ITRF2000 at epoch of 2003 survey to support comparison.

Station Name	X (mm)	Y (mm)	Z (mm)
YAR2	-0.5	-0.6	-0.6
YARR	0.2	0.7	0.6
DN95	-0.4	-0.2	-0.3
YASB	1.5	-0.1	1.8
YASM	-0.2	0.4	0.6
YARM	0.7	0.3	0.0
YIVP	-1.0	0.4	0.8
RMS	0.8	0.5	0.8

Table 13: East, North and Up Residuals between the 2003 and 2007 surveys.

Station Name	E (mm)	N (mm)	Up (mm)
YAR2	0.7	-0.7	0.0
YARR	-0.5	0.8	0.2
DN95	0.4	-0.3	0.1
YASB	-1.3	1.2	-1.5
YASM	0	0.7	0.1
YARM	-0.8	0.0	0.0
YIVP	0.7	1.1	0.3
RMS	0.8	0.7	0.6



6. Planning Aspects

The terrestrial network at Yarragadee is highly over determined and it takes a considerable amount of time and effort to observe between the network of survey marks. Several significant monuments, such as DON95 (primary ground reference mark for the MOBLAS 5 SLR system) are difficult to survey accurately which has led to the densification of the ground network (two temporary bench marks) to support viewing of such survey marks. DON95 is located under the SLR structure, in a confined space, prohibiting the use of a tripod. Its location also restricts the geometry of observations to it. A special forced centring, fixed height plate mount has been constructed for observing this point, and is kept at Geoscience Australia. The height of this mount was calibrated prior to conducting the local tie survey. The two TBMs installed for observation of DON95 are steel screws in bitumen. These survey marks can be difficult to locate. The surveyor should know the TBMs positions with respect to surrounding survey marks prior to commencing the survey.

It was intended that magnetic mounted, precision prisms be used throughout the survey of the telescope. However, the telescope is aluminium (non-magnetic) which prevented the use of the magnetic mounts. Therefore, leica retro-reflective tape targets had to be used for the elevation survey. Leica precision prisms, mounted in tribrachs were used for the azimuth rotation survey. To attach targets onto the two trunnion supports of the telescope structure, custom made screws were utilised. These screws have different sized threads to support connection to the telescope and the tribrach. The screws were left on the telescope structure on site. In addition, a modified tribrach was used to place a target in the centre of the telescope. This tribrach sits in a plate on the underside of the telescope, thus the telescope had to be rotated to a backwards orientation and several hardware elements of the telescope had to be removed. This tribrach is stored on site. A new/alternative, more stable mount is required for future surveys as the mount used for this survey was noticed to be unstable during the survey.

During the azimuth survey, with the telescope rotated in a backward orientation, the telescope should be locked in elevation (approx 177°) using dump mode (controlled from the telescope control room) for ensured stability. Be aware that the telescope cannot be pointed directly at the sun. The survey should be timed to avoid orientations toward the sun.

The observation of GPS data is a significant component of the overall survey. The observation of suitable data spans needs to be considered in the context of normal terrestrial survey activities.

Adequate time should be allocated to complete the local tie survey. At least five full days are required to conduct the local tie survey. The terrestrial network survey takes approximately two full days. The levelling survey should be allocated one full day. Levelling results should be checked in the field to ensure closure before leaving the site. It takes approximately three hours to setup for the SLR azimuth/elevation surveys. SLR elevation observation from one setup takes approximately three hours (observing six targets manually). SLR azimuth observation from one setup takes approximately two hours when observing three targets using automatic target recognition (ATR). Be aware that SLR operator change over times are at 3am and 3pm. Try to ensure one operator for each SLR rotation survey. Reuger heighting is required before and after SLR observation sessions. If conducting an upgrade to the ARGN equipment when on site, allow more time. One full day of travel is required for travel from Canberra to Perth to the tracking station. If driving to Geraldton allow half a day as it takes approximately 1.5 hours one way. Recommend surveyors stay in Mingenew, which is a 20 minute drive from the tracking station.



The 2007 Yarragadee (Moblas 5) Local Tie Survey

Undertake a comprehensive calibration of the ZNL optical plummet, leica optical plummets and total station before freighting equipment for the survey. Ensure the plummets are in alignment to prevent confusion and reduced confidence in survey instrument setup during the terrestrial network survey.

An imperial allen key set is required to remove YAR2 from the support mount.

The DORIS beacon is not to be moved during the local tie survey, thus the total station cannot be setup over the DORIS pillar plate spigot (YASM). It was difficult to maintain the stability of the total station when set up on the calibration pillars

The coordinates of the calibration pillar monuments were derived through the survey process. The computation of the effective point of reflection of the calibration reflectors relied upon the measurement of the prism offset and height external to the survey process. In the future more in-depth analysis of these prisms offsets needs to be completed.

While local tie surveys are a significant technique for reference frame definition, every attempt should be made to minimise disruption to normal SLR activities. The timing of future surveys needs to be negotiated with the MOBLAS 5 manger to avoid unnecessary negative impact on ranging productivity, especially for high priority satellite missions.



7. References

Dawson, J., Sarti, P., Johnston, G. and Vittuari, L., 2007. Indirect Approach to Invariant Point Determination for SLR and VLBI Systems: An Assessment, *Journal of Geodesy, Special Issue VLBI*, June 2007, Vol 81, No. 6-8.

Johnston, G. and Dawson, J., 2004. The 2003 Yarragadee (Moblas 5) Local Tie Survey. *Geoscience Australia Record*, 2004/19, 27pp.

Johnston, G., Dawson, J. and Naebkhil, S., 2004. The 2003 Mount Stromlo Local Tie Survey. *Geoscience Australia Record*, 2004/20, 25pp. Available online: <http://www.ga.gov.au/image_cache/GA5653.pdf>

Johnston G., and Digney P., 2002. Mt Stromlo Satellite Laser Ranging Observatory Local Tie Survey, Technical Report 9, *Australian Surveying and Land Information Group (AUSLIG) Geodesy Technical Report 9*. Available online: <http://www.ga.gov.au/image_cache/GA5026.pdf>

Johnston G., Dawson J., Twilley B. and Digney P., 2000. Accurate Survey Connections between Co-located Space Geodesy Techniques at Australian Fundamental Geodetic Observatories, *Australian Surveying and Land Information Group (AUSLIG) Geodesy Technical Report 3*, available online: http://www.ga.gov.au/image_cache/GA5035.pdf

Rueger J. M., and Brunner F.K., 1981. Practical results of EDM-Height Traversing, *The Australian Surveyor*, June, 1981, Vol. 30, No. 6.

7.1 Name of person responsible for observations

Alex Woods, Geodesist
Geoscience Australia
Cnr Jerrabomberra Ave and Hindmarsh Drive
GPO Box 378
Canberra ACT 2601 Australia
Phone: +61 2 6249 9049
Email: Alex.Woods@ga.gov.au

7.2 Name of person responsible for analysis

7.2.1 Data reduction and classical adjustment

Alex Woods, Geodesist, contact details are as above

7.2.2 GPS analysis, IVP determination, alignment and SINEX

Ryan Ruddick, Geodesist
Geoscience Australia
Cnr Jerrabomberra Ave and Hindmarsh Drive
GPO Box 378
Canberra ACT 2601 Australia
Phone: +61 2 6249 9426
Email: Ryan.Ruddick@ga.gov.au

Alex Woods, Geodesist, contact details are as above



7.3 Location of observation data and results archive

Alex Woods, Geodesist, contact details are as above

